

Kodak

PIXPRO FZ201

Digital Camera

User Manual



BEFORE YOU START

Declaration of Conformity

Responsible Party: JK Imaging Ltd.

Address: JK Imaging Ltd., 17239 South Main Street, Gardena, CA 90248, USA

JK Imaging Europe, 71 Clarendon road, Watford, WD17 1DS, UK

Company website: www.kodakpixpro.com

For Customers in the U.S.A.

Tested to Comply with FCC Standards FOR HOME OR OFFICE USE

This device complies with part 15 of the FCC Rules. Operation is subject to the following two conditions: (1) This device may not cause harmful interference, and (2) this device must accept any interference received, including interference that may cause undesired operation.

For Customers in Europe

 "CE" mark indicates that this product complies with the European requirements for safety, health, environment and customer protection. "CE" marked cameras are intended for sales in Europe.



This symbol [crossed-out wheel bin WEEE Annex IV] indicates separate collection of electrical waste and electronic equipment in the European countries. Please do not throw the equipment into domestic refuse. Please use the return and collection systems available in your country for proper, safe disposal of this product.

About this Manual

Thank you for purchasing this KODAK PIXPRO digital camera. Please read this manual carefully and keep it in a safe place for future reference.

- JK Imaging Ltd. reserves all rights of this document. No part of this published manual may be reproduced, transmitted, transcribed, stored in a retrieval system or translated into any language or computer language, in any form, by any means, without the prior written permission of JK Imaging Ltd..
- All trademarks mentioned in this manual are used for identification purposes only and are properties of their respective owners.
- This manual will instruct you on how to operate the KODAK PIXPRO digital camera. JK Imaging Ltd. has tried its utmost to ensure the correctness of the user manual contents, but reserves the right to modify as necessary. All of these contents are subject to change without prior notice.
- Throughout this manual, the following symbols are used to help you locate information quickly and easily:



Indicates useful information.

- In the instructions below, the following symbols may be used throughout this manual on how to operate the camera. This is to facilitate better understanding.

[Item properties] : The optional properties in the camera interface are indicated by the symbol [] .

SAFETY NOTES

Safety notes for this camera

- Do not drop the camera or allow it to hit solid objects.
- Do not attempt to disassemble or repair the camera.
- Do not use or store the camera in dusty places or on a beach to prevent dust or sand from entering the camera, causing possible damage to it.
- Do not use or store the camera in a hot environment or under direct sunlight.
- Do not use or store the camera near a powerful magnetic field, for example near a magnet or transformer.
- Avoid touching the lens of the camera.
- Do not expose the camera to direct sunlight for a long period of time.
- To prevent the camera from being damaged by moisture, do not use or store the camera in very humid environments, such as in rain or near bodies of water.
- If water accidentally comes in contact with the camera, turn the camera off, remove the battery and the memory card, and dry it within 24 hours.
- When you take the camera from a cold place to a warmer environment, condensation may occur. Please wait for a reasonable period of time before you turn it on.
- Before you remove the battery and memory card, the camera should be turned off.
- When you clean the body of the camera, do not use abrasive, alcohol-based or organic cleaner.
- Use a professional lens wiping cloth and dedicated cleaner to wipe and clean the lens.
- Download your photos and remove the memory card when you are going to store the camera for a long period of time.
- If this camera is not in use for a long time, please keep it in a dry and clean condition.
- Our company will not pay compensation for any failure of playback of pictures or videos caused by improper operation.

Safety notes for battery

- Please use a battery that is the same type as the one included.
- Please use the attached charger to charge the battery.
- If battery fluid leaks inside the camera, contact our customer service department. If battery fluid leaks onto your skin, rinse your skin with clean water and seek immediate medical attention.
- Disposal of used batteries should be carried out in accordance with the local (national or regional) regulations.
- To prevent the battery from being damaged, do not drop the battery or allow it to hit solid objects or to be scratched by the objects.
- Do not let the battery come in contact with metal objects (including coins) to avoid short circuiting, discharging, excessive heat, or possible leakage.
- Do not attempt to disassemble the battery.
- Do not expose the battery to water. Always keep the battery contacts dry.
- Do not heat the battery or throw it into a fire to avoid a possible explosion.
- Do not store the battery in a hot environment or in direct sunlight.
- If the battery overheats during charging or use, stop charging or use immediately. Turn off the product, remove the battery carefully, and wait until it cools down.
- When the camera is stored for a long period of time, remove the battery and keep it in a dry place that is not accessible to infants and children.
- In a colder environment, the performance of the battery could be noticeably reduced.
- When you install the battery, install it according to the positive and negative markings on the battery compartment. Never force it into the battery compartment.

Safety notes for memory card

- We suggest buying only well-known, name brand memory cards to ensure peak performance.
- Format the memory card using the camera before you use it or insert a new one.
- Do not drop the memory card or allow it to hit solid objects to avoid damaging it.
- Do not attempt to disassemble or repair the memory card.
- Do not expose the memory card to water. Always keep it dry.
- Do not remove the memory card when the camera is turned on. Otherwise, the memory card could be damaged.
- Do not directly edit the data on the memory card. Copy the data to your PC before you edit them.
- When the camera is stored for a long period of time, be sure to download your photos and remove the memory card. Store it in a dry environment.
- Do not modify the name of the files or folders of the memory card using your PC. Modifying the file names may cause the files to not be recognized on the camera or a possible error may occur.
- A photo taken with the camera will be stored in the folder that is automatically generated on the memory card. Do not store photos that are not taken using this camera in these folders as the pictures cannot be recognized during the playback.
- When you insert a memory card, make sure the notch of the card matches the markings on the top of the card slot.

Other Safety Notes

- Do not disconnect the power or turn the camera off during the update process. Doing so may cause incorrect data to be written and the camera may not power on later.
- Do not hang the neck strap of the camera around the neck of a child.
- When using your camera on an airplane, observe the relevant rules specified by the airline.
- Due to the limitations of manufacturing technology, the LCD may have a few dead or bright pixels. These pixels do not affect the quality or performance of the camera, photos or video.
- Do not expose the LCD to water. In a humid environment, only wipe it with a soft and dry cleaning cloth.
- If the LCD is damaged and the liquid crystal comes into contact with your skin, wipe your skin with a dry cloth immediately and rinse it with clean water. If liquid crystal comes into contact with your eyes, wash them with clean water at least for 15 minutes and seek immediate medical attention. If you accidentally swallow liquid crystal, rinse your mouth immediately and seek medical attention.

CONTENTS

BEFORE YOU START	1	MODE OVERVIEW	22
SAFETY NOTES	3	Display Setting	22
CONTENTS.....	7	LCD Screen Display.....	23
GETTING READY	11	Overview of the Screen Icons in Photo Shooting Mode.....	23
Accessories Included.....	11	Overview of the Screen Icons in Movie Mode...25	
Install neck strap	12	Using the Mode Button	26
Part Names	13	Panorama Mode.....	27
Installing Battery and Memory Card.....	15	Scene Mode	28
Charging Battery.....	17	Auto Scene Mode (ASCN)	31
Turning Camera On and Off.....	18	BASIC OPERATION.....	32
How to take pictures.....	18	Using the Zoom Function.....	32
Set your Language, Date/Time	19	Macro Mode.....	33
Set your Language, Date/Time after the first power-on	19	Self-timer Setting	34
Resetting your Language.....	20	Flash Mode	35
Resetting Date/Time.....	21	EV Setting.....	36
		Exposure Compensation	36

ISO	37	Focus Setting	48
Shutter Adjustment.....	37	Continuous Shot	48
Using Quick Recording.....	38	Color Effect	49
PLAYBACK.....	39	Shooting Setting Menu.....	51
Overview of the Screen Icons in Playback Mode....	39	Quality	51
Viewing Photos and Videos.....	40	AF Assist Beam	52
Thumbnail View.....	41	Digital Zoom.....	52
Using Zoom Playback (for still pictures only).....	42	Date Imprint	53
Slideshow	43	Quick Review	53
Photos and Video Deletion	44	Face Detection	54
USING THE MENUS	45	Movie Menu	55
Shooting Menu.....	45	Expo Metering.....	55
Expo Metering	45	Video Quality.....	56
Image Size	46	OIS	57
OIS	46	Color Effect	57
White Balance Setting.....	47	Movie Setting Menu	58
Cont. AF.....	47	Digital Zoom.....	58
		Playback Menu	59

HDR	59
Red-Eye Reduction	60
Rotate.....	60
Resize	61
Color Effect	61
Playback Setting Menu.....	62
Protect.....	63
Delete.....	63
DPOF (Digital Print Order Format).....	64
Trim.....	64
Setup Menu	65
Sound Settings	66
Power Saver	66
Language	67
World Time.....	67
Date & Time.....	67
LCD Brightness.....	67
File Setting	68

Format.....	68
Copy to Card.....	69
File Numbering.....	69
Reset.....	70
FW Version	70

CONNECTIONS..... 71

Connecting to a Computer	71
Setting the USB Mode	71
Transferring files to your computer	72
Connecting to a PictBridge Compatible Printer	73
Setting the USB Mode	73
Connecting to your Printer	74
Using the PictBridge Menu.....	75
Print (with Date).....	75
Print (without Date).....	76
Print Index	77
Print DPOF Images	78

Exit	78
Video System	79
Set Eye-Fi SD Card Connection Mode.....	80
APPENDICES	81
Specifications	81
Prompts and Warning Messages.....	85
Troubleshooting.....	89

GETTING READY

Accessories Included

Your camera box should contain the camera model you purchased along with the following accessories. If anything is missing or appears to be damaged, please contact your retailer. (Based on sales in different countries or regions, the shape of the AC adapter will vary. Please subject to the actual product will prevail.)

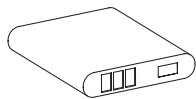

Rechargeable
Li-ion battery

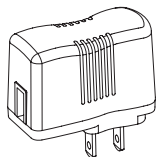

AC adapter

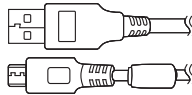

Micro USB cable



Neck strap



Quick start guide



Warranty card



Service card

Install neck strap

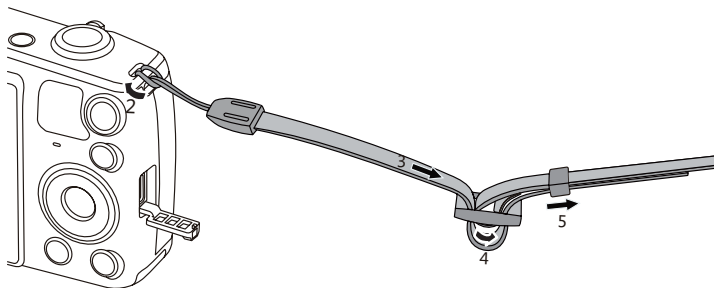
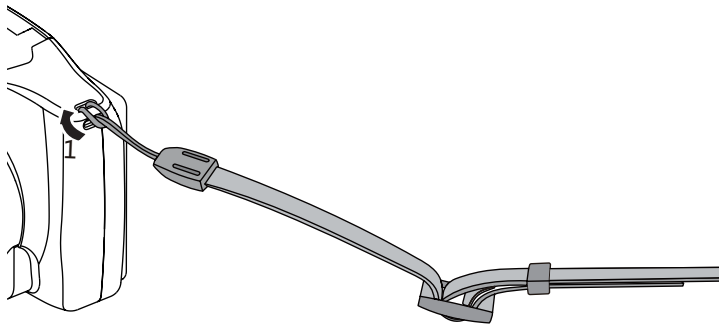

Part Names

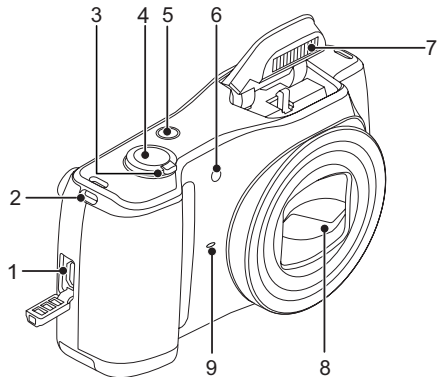

1. Micro USB port
2. Strap eyelet
3. Zoom lever
4. Shutter button
5. Power button
6. AF assist beam/Self-timer lamp
7. Flash lamp
8. Lens
9. Microphone

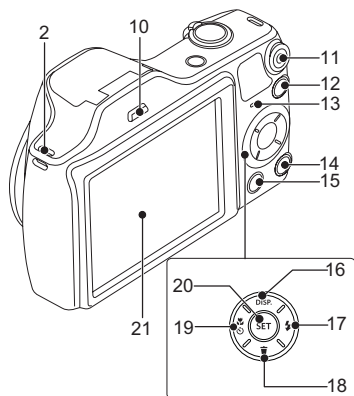

- 10. Flash pop-up button
- 11. Fast video recording button
- 12. Mode button
- 13. Indicator lamp
- 14. Playback button
- 15. Menu button
- 16. Display button/Up button
- 17. Flash button/Right button
- 18. Delete button/Down button
- 19. Macro button/Self-timer button/Left button
- 20. SET button
- 21. LCD

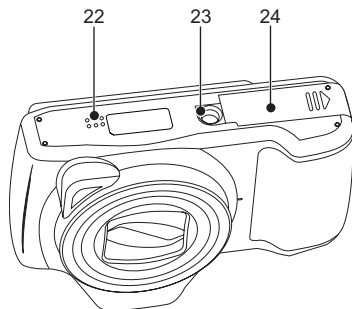

- 22. Speaker
- 23. Tripod socket
- 24. Battery cover

Installing Battery and Memory Card

1. Open the battery cover.

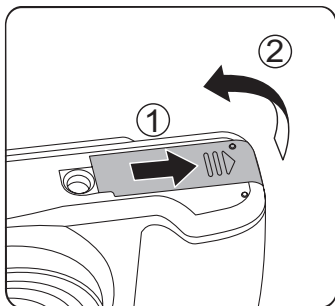

2. Insert the battery into the battery compartment according to the negative and positive directions as illustrated in the picture. Push the battery down until it locks in place.

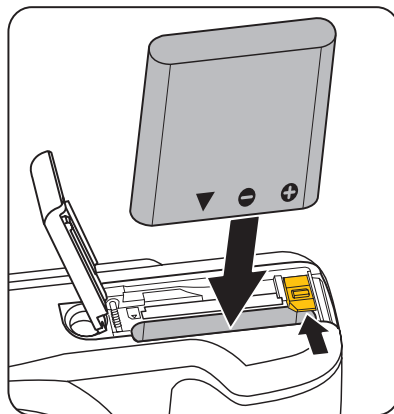

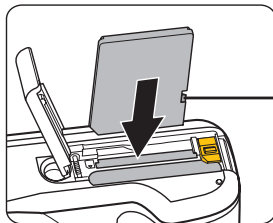

3. Insert the memory card into the memory card slot as shown in the diagram below:

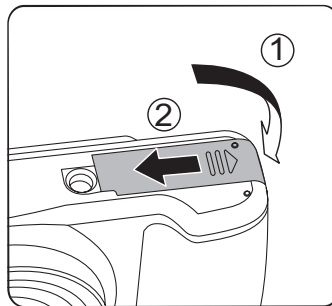

Write protection buckle

4. Close the battery cover.



 The memory card (SD/SDHC) is optional and not included in all camera packaging. If you have to purchase a memory card, select one with storage capacity between 4GB and 32GB to ensure correct data storage.

 To remove your memory card, open the battery cover, gently press the memory card to eject it and remove it carefully.

Charging Battery

Please insert the battery and charge it under shutdown mode.

1. Connect the camera and the power charger using the supplied Micro USB cable.
2. Insert the plug of the power charger into the power outlet to charge the battery.
3. When the camera is turned off, you can also connect the camera to your PC using a USB cable to charge the battery.

 After the battery is stored for a long period of time, use the supplied power charger to charge the battery prior to use.

 **Charging indicator:**
Steady orange: Charging.
The indicator will go out once charging is finished.
To have maximum battery life, charge the battery for at least 4 hours the first time.

 Please charge the battery indoors between 0°C and 40°C.

 The camera will only charge while powered off. If the camera is turned on while connected to power, normal camera functions will be available for use, but the camera will not charge until it is turned off.

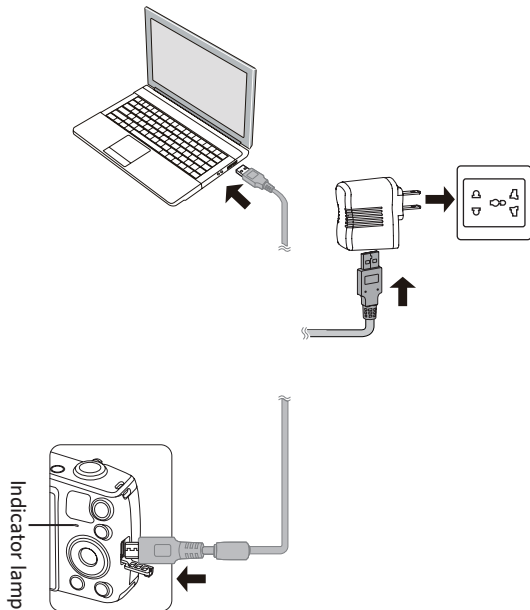

Turning Camera On and Off

Press the power button to turn the camera on. To turn the camera off, press the power button again.

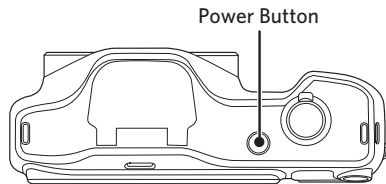

When the power is off, press and hold the  button to power on and enter playback mode.

How to take pictures

1. Hold the camera with both hands , not blocking the flash and lens by fingers.
2. Aim the camera at the object and then frame with the LCD.
3. Use the zoom lever to select Tele or Wide positions to zoom in or out on your subject.
4. Press the shutter button half way to focus on the subject. When the focus frame turns green, press the shutter button completely down to take the picture.

Set your Language, Date/Time





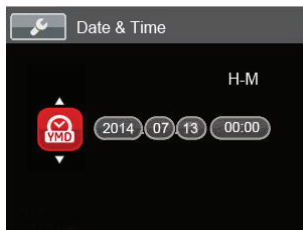



Set your Language, Date/Time after the first power-on

1. When you turn the camera on for the first time, the language selection screen appears.
2. Press the direction buttons to select your desired language.
3. After you press the **(SET)** button to confirm the selection, the Date/Time settings screen appears.
4. Press the left/right button to select the Date/Time to be adjusted: Time is displayed in YYYY.MM.DD HH:MM.
5. Press the up/down button to adjust the value for the selected Date/Time.
6. Press the **(SET)** button to confirm the time settings and the snapshot screen appears.



Resetting your Language





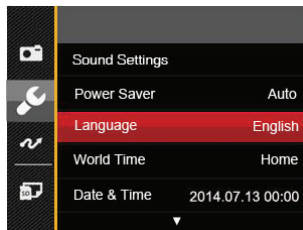



After you set your language for the first time, follow the instructions below to reset your language.

1. Press the  button, press the up/down button to select , and press the  button to enter the menu.
2. Press the up/down button to select , and press the  button or right button to enter the menu.
3. Press the up/down button to select [Language] and press the  button or right button to enter the menu.
4. Press the direction buttons to select your desired language and press the  button to confirm.
5. Press the  button and the snapshot screen appears.



Resetting Date/Time

After you set your Date/Time for the first time, follow the instructions below to reset date and time.

1. Press the  button, press the up/down button to select , and press the  button to enter the menu.
2. Press the up/down button to select , and press the  button or right button to enter the menu.
3. Press the up/down button to select [Date & Time] and press the  button or right button to enter the menu.
4. Press the left/right button to select the Date/Time to be adjusted: Time is displayed in YYYY.MM.DD HH:MM.
5. Press the up/down button to press the value for your selected block. After you finish your settings, press the  button to confirm.
6. Press the  button and the following snapshot screen appears.

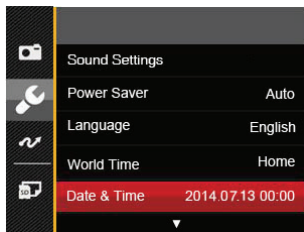

MODE OVERVIEW

Display Setting

Press the **DISP.** button to display the settings: Classic, Full, Off.

Classic: Displays the camera parameters on screen



Off: Does not display any additional icons on screen

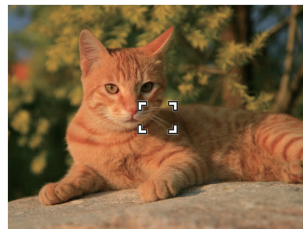

Full: Camera parameters with Grid and Histogram

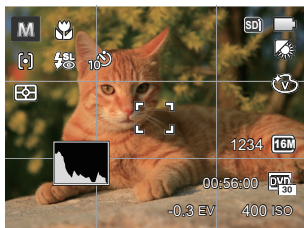

LCD Screen Display

Overview of the Screen Icons in Photo Shooting Mode

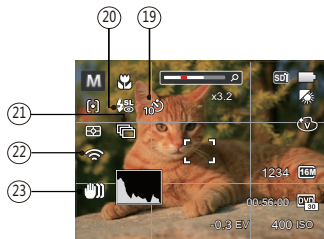
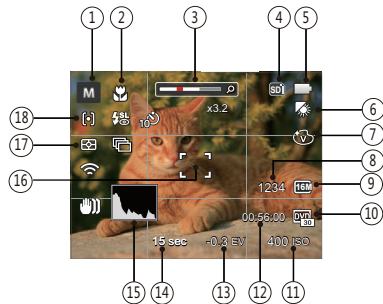

1 Shooting Mode

Auto Mode Panorama Mode

Manual Mode Scene Mode

Portrait Mode

2 Macro Mode

3 Zoom Display (By turning the Zoom Lever)

4 SD Memory Card/Built-in Memory

5 Battery Status

6 White Balance (Adjustable in mode)

7 Color Effect (Adjustable in mode)

8 Number of remaining shots

9 Image Size

10 Video Quality

11 ISO Value (Adjustable in mode)

12 Remaining Recording time

13 Exposure Compensation (EV value) (Adjustable in mode)

14 Shutter Speed (Adjustable in  mode)

15 Histogram

16 Focus Frame

17 Expo Metering



AiAE



Spot



Center

18 AF Mode



Single-AF

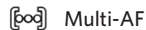

Multi-AF

19 Self-timer



Self-timer Off



Self-timer 2 sec



Self-timer 10 sec



Self-timer Smile

20 Flash Mode



Force Off



Flash Auto



Fill Flash



Slow Sync.



Slow Sync. + Red-Eye



Red-Eye Reduction

21 Continuous Shot



Single



Continuous Shot



3 Shots





Time Lapse (30sec/1min/5min/10min)

22 Eye-Fi ON (with signal)

23 Image Stabilization

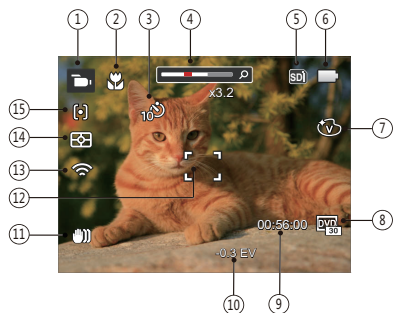
Overview of the Screen Icons in Movie Mode



- 1 Movie Mode
- 2 Macro Mode
- 3 Self-timer
 -  Self-timer Off
 -  Self-timer 10 sec
- 4 Zoom Display (By turning the Zoom Lever)
- 5 SD Memory Card/Built-in Memory
- 6 Battery Status

- 7 Color Effect
- 8 Video Quality
- 9 Remaining Recording time
- 10 Exposure Compensation (EV value)
- 11 Image Stabilization
- 12 Focus Frame
- 13 Eye-Fi ON (with signal)
- 14 Expo Metering



AiAE



Spot



Center

- 15 AF Mode











For optimal video shooting, it is recommended that an SDHC memory card be used.



Optical Zoom and Digital Zoom can be adjusted (80X in total). Digital Zoom can be adjusted to 4X .

Using the Mode Button

This camera provides a convenient mode button that allows you to switch easily among different modes. After pressing the  button to enter the mode selection menu, press the left/right button to choose the selected mode. Press the  button to confirm your selection. All the available modes are listed below:

Mode Name	Icon	Description
Auto Mode		In this mode, the optimal conditions for taking pictures will be set based on the subject and environment. It is the most commonly used mode for taking pictures.
Manual Mode		This mode is for manually setting EV, shutter speed and ISO value.
Portrait Mode		The best setting for portrait shooting, enables AE/AF for faces. The camera is set to automatically adjust exposure for realistic capture of skin tones.
Movie Mode		Record videos.
Panorama Mode		In this mode, up to 4 frames can be stitched together to create a single panoramic photo.
Scene Mode		Choose from 20 different pre-set scene types and effects for your photos.



Panorama Mode

Panorama mode allows you to create a panoramic picture. The camera will automatically compose a panoramic picture using the individual shots that you take.

Follow these easy steps to create a panoramic picture:

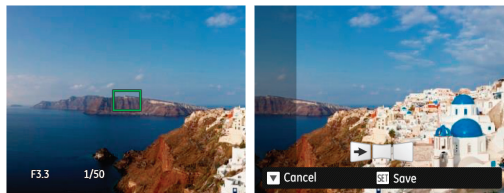
1. Press the **(MODE)** button to select panorama mode ().
2. Press the direction buttons to select a shooting direction. (The right direction is used as default if you do not make any choice) 2 seconds later, the camera is ready to take pictures. You can also press the **(SET)** button or half press the shutter button to be ready to take pictures.
3. Compose the first view of the panoramic picture on the LCD and press the Shutter button to capture the image.
4. After the first shot is taken, the semi-transparent image of the first shot will appear at the edge of the screen. You can use this image to compose your picture before you press the Shutter button to capture and finish manual stitching.



5. If continuous pictures are less than 4 shots, press the **(SET)** button, the camera will splice the pictures automatically. Press playback button to enter playback mode to see the effect.
 6. If you take 4 pictures, the camera will splice the pictures automatically. Press playback button to enter playback mode to see the effect.
-  During shooting, the flash, self-timer, macro modes and exposure compensation are not available. Focus adjustment is also not available at this time.
-  In panorama mode, up to 4 photos can be captured when the image size is set at 2M.



During panorama mode shooting, press the **(SET)** button to interrupt shooting and save the current pictures taken. Press the down button (**⏏**) to cancel shooting and not to save the previously taken pictures.







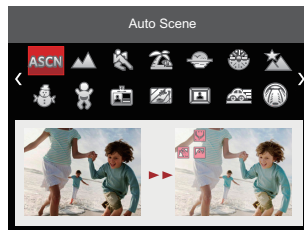





Scene Mode **SCN**









You can select an appropriate mode from the 20 scene modes according to the type of environment you are shooting. The camera then configures the most appropriate settings automatically.

1. Press the **(MODE)** button to select scene mode (**SCN**). The LCD will display a menu like the example below:



2. Press the direction buttons to select a scene, and press the **(SET)** button to confirm.
3. If any need of changing the scene, please press the **(MENU)** button and then the **(SET)** button and finally the direction buttons to reselect the scene.







Scene	Description
 Auto Scene	Identifies the scene automatically; Person, Backlighting, Landscape, Macro, Night Scene, Night Scene Person, Auto.
 Landscape	For landscapes and outdoor shots. Vivid reproduction of green and blue.
 Sport	For fast-moving subjects. Capture sharp, action shots with minimal blur. This mode is not recommended for shooting indoors.
 Beach	For taking pictures in areas with strong sunlight.
 Sunset	For sunsets. Capture subjects in strong sunlight.
 Fireworks	For fireworks at night. Suggest using tripod.
 Night Landscape	For night scenes. Suggest using tripod.
 Snow	For snow scenes. Reproduce natural, clear white scenes.
 Children	Turns off flash automatically. Avoids disturbing subject, suitable for taking photos of children.
 ID	For shooting ID size photos. (It is recommended to print using 6-inch 4R (6X4) photographic paper).
 Glass	For objects behind transparent glass.
 Photo Frame	For adding interesting frame effects to the photo.

Scene	Description
 Panning Shot	Suitable for capturing fast moving objects to have a clear subject with a blurred background.
 Fish Eye	For interesting fish eye effect.
 Party	Suitable for taking indoor party pictures, even under the complicated lighting conditions.
 Indoor	For indoor settings. Reduce blur and improve color accuracy.
 Leaf	For plants. Capture brilliant shots of greenery and blossoms.
 Museum	For museums or flash-free areas. Retain color and reduce blur.
 Night Portrait	For portraits against night scenery.
 Sketch	For taking photos with pencil sketch effect.

Auto Scene Mode (ASCN)

In “ASCN” scene mode, the camera can detect different environments intelligently and automatically select the best scene and photo settings for you.

“ASCN” can intelligently detect the following scenes:

Mode Name	Description
 Landscape Mode	For landscapes, will automatically adjust the exposure and reproduce vivid green and blue colors.
 Portrait Mode	Most suitable for capturing people with focus on their faces.
 Night Portrait	When you take portraits at night, or in low light conditions, will automatically adjust the exposure for people and night scenes.
 Backlit Portrait	When the sun or any other light source is behind you, will automatically adjust the foreground exposure to produce the best pictures possible.
 Night Landscape Mode	For night scenes, will automatically increase the ISO value to compensate for low light.
 Macro Mode	The Macro setting is ideal for shooting small objects or close-up photos.
 Auto Mode	The camera will automatically adjust the exposure and focus to ensure the best possible pictures.

BASIC OPERATION

Using the Zoom Function

Your camera is equipped with two types of zoom functions: optical zoom and digital zoom. Toggle the zoom lever of the camera to zoom in or out of the subject while taking pictures.

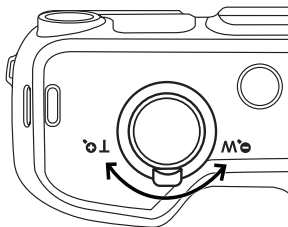

Zoom Lever

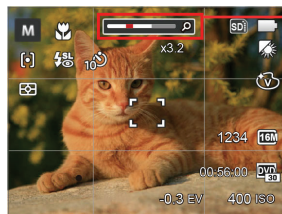

Zoom Indicator

When the optical zoom reaches the threshold as digital zoom, release and turn the zoom lever to T to switch between the optical zoom and digital zoom.



Macro Mode

The macro setting is ideal for shooting small objects or close-up photos. This mode allows you to focus on subjects very close to the camera.

1. Press the left button ( ) to enter the macro menu.



2. Press the left/right button to select the following 2 modes:

-  **Macro Off**
Select this option to disable macro.
 -  **Macro On**
Select this option to make focusing on the object closer to the lens (At the W side, the shooting distance should be more than 3 cm).
3. Press the  button to confirm the settings and enter the shooting screen.



Self-timer Setting



Use this function to take pictures at pre-set intervals. First choose 2 seconds, 10 seconds, or by smile detection, and then take the pictures.

1. Press the left button ( ), and then press the down button () to enter the self-timer menu.







2. Press the left/right button to select the following 4 modes:

-  Self-timer Off
Disables the self-timer.
-  Self-timer 2 sec
A single picture is shot 2 seconds after the shutter button is pressed.

-  Self-timer 10 sec
A single picture is shot 10 seconds after the shutter button is pressed.
-  Self-timer Smile
Press the shutter button and a picture will be taken immediately after a smile is detected.



3. Press the  button to confirm the settings and enter the shooting screen.

 When enabling the self-timer, pressing the shutter or the () button can disable the self-timer and return to the shooting screen while keeping the self-timer setting.

 When enabling the smile detection, pressing the shutter or the  button can disable the self-timer and return to the shooting screen without keeping the Self-timer Smile setting.



Flash Mode



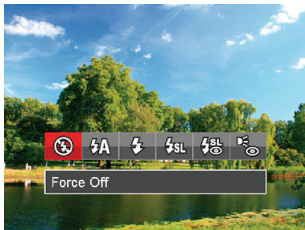

The flash provides supplemental light for the scene. The flash is usually used when shooting against the light to highlight the object; it is also suitable for metering and shooting in darker scenes to improve the exposure.

1. Press the flash pop up button  to pop up the flash.
2. Press the right button () to enter the flash settings menu.



3. Press the left/right button to select the following 6 modes:

-  Force Off
Flash is turned off.
-  Flash Auto
Camera flash goes off automatically based on existing light conditions.

-  Force Flash
The flash will engage with each shot even if there is enough available light to take the photo without flash.
 -  Slow Sync.
This allows you to take pictures of people at night that clearly show both your subjects and the night time backdrop. The use of a tripod is recommended when shooting with this setting.
 -  Slow Sync. + Red-Eye
Use this mode for slow synchrony shots with red-eye reduction.
 -  Red-Eye Reduction
The camera emits a brief pre-flash before the picture is taken to reduce red-eye effects.
4. Press the  button to confirm the settings and enter the shooting screen.

EV Setting

The EV function menu of the camera includes functions, such as EV, shutter adjustment, ISO. Using the appropriate function settings can improve your pictures.

To select the best setting for optimum photos, follow these steps:

1. Press the **(SET)** button to display the settings screen.
2. Press the left/right button to select the setting options.
3. Press the up/down button to adjust the option values.
4. Press the **(SET)** button to complete the setting and enter shooting mode.

Exposure Compensation

Set up to adjust the picture brightness. In the case of a very high contrast between the photographed object and the background, the brightness of the picture can be appropriately adjusted. (Adjustable in **(M)** **(P)** mode)

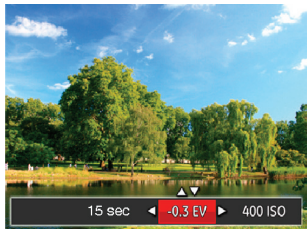

The adjustable range of exposure value is from EV -2.0 to EV+2.0.

ISO

The ISO function allows you to set the sensitivity of the camera's light sensor based on the brightness of the scene. To improve the camera's sensor performance in darker environments, a higher ISO value is required. A lower ISO value is needed when shooting in brighter conditions.

Pictures taken at higher ISO settings will generally have more noise than those taken at lower ISO settings. (Adjustable in  mode)

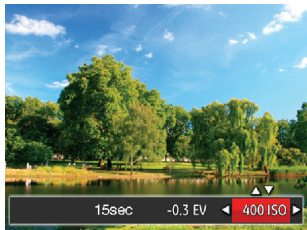

The camera's ISO settings include: Auto, 80, 100, 200, 400, 800, 1600.

Shutter Adjustment

For shutter speed, the camera may automatically set the aperture value corresponding to the manually set shutter speed so as to obtain a most suitable exposure value. The movement of object may be shown by adjusting the shutter speed. High shutter value can make you clearly capture the movement of fast moving object while low shutter value can allow you to take a picture for fast moving object with a strong sense of movement. (Adjustable in  mode)

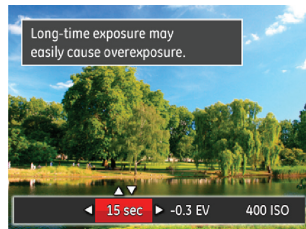

Using Quick Recording

In shooting mode, press the  button to begin recording video.

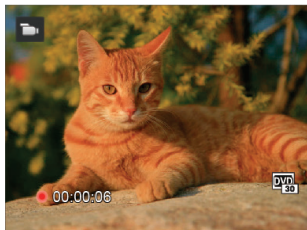

After recording, press the  button or the shutter button to stop recording. The camera will store the video and return to the shooting screen.

Overview of the Screen Icons in Playback Mode

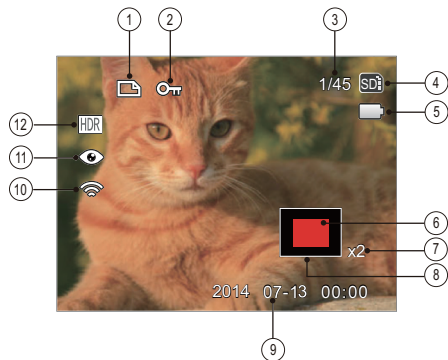

- 1 DPOF File
- 2 File Protection
- 3 Memory space (indicating the current number of photos and total number of photos)
- 4 SD Memory Card/Built-in Memory
- 5 Battery Status
- 6 Zoom Magnification Area
- 7 Image Zoom Ratios
- 8 Image Zone
- 9 Shooting Date
- 10 Eye-Fi ON (with signal)
- 11 Red-Eye Reduction
- 12 HDR

Viewing Photos and Videos

To view the captured photos and video clips on the LCD:

1. After pressing the **(▶)** button, the last photo or video clip taken will be displayed on the LCD.
2. Use the left/right navigation buttons to scroll through the photos or video clips stored in the internal memory or on the memory card.
3. To play a selected video clip, press the **(SET)** button to enter the movie playback mode.

An operation guide appears on the screen when playing back a video. Press the appropriate buttons to enable the corresponding functions.

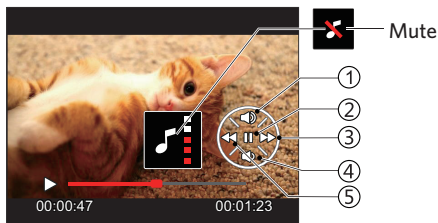

1	Increase volume
2	Pause
3	Fast forward
4	Decrease volume
5	Rewind

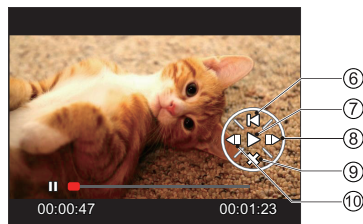

6	Back to the beginning of the video
7	Play
8	Play video forward
9	Cancel playback
10	Play video backward

Thumbnail View

When in playback mode, rotate the zoom lever counter to the **W**  position to display thumbnail images of the photos and videos on the screen.

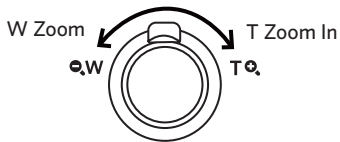

1. Slide the zoom lever to switch between 3x3 and 4x4 thumbnails.

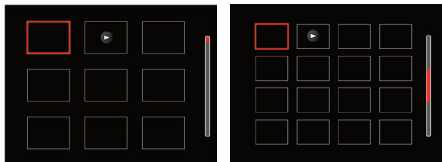

2. Press the direction buttons to select a picture or video clip to view and press the **(SET)** button to restore it to the original size.



If the  indicator appears on the LCD, then a movie file is currently being displayed.

Using Zoom Playback (for still pictures only)

The zoom lever can also be used during playback. This allows you to magnify photos between x2 to x8.

1. Press the **▶** button to switch to playback mode.
2. Press the left/right button to select a picture to be zoomed in.
3. Rotate the zoom lever to (**⊕** **T**) to zoom in.
4. The screen will display the number of times and area of the photo zooming operation.

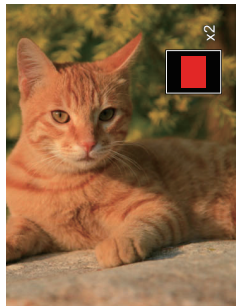
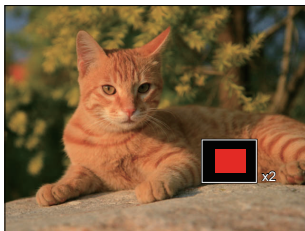



5. Press the direction buttons to navigate and select a part of the image to be zoomed in.
6. Press the **(SET)** button to return the image to its original scale.







Movie images cannot be magnified.

Slideshow

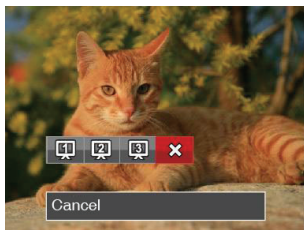
This setting allows you to view all the stored images as a slideshow.

1. Press the  button to enter playback screen.
2. Press the  button to enter slide option.
3. Press the left/right button to select slideshow playing or [Cancel] to return to the playback screen.





4. Press the  button to confirm the setting.
-  Slide playing function supports movie playing.
 -  Images don't rotate in the slideshow playback.

Photos and Video Deletion



In playback mode, press the down button () to delete your photos and videos.

To delete photos or videos:

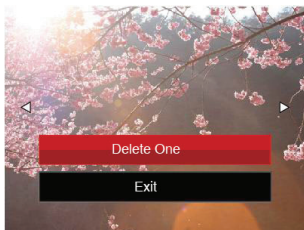
1. Press the () button to switch to playback mode.
2. Press the left/right button to select the photos and videos to be deleted.
3. Press the down button () and the deletion screen is displayed.



4. Press the up/down button to select [Delete One] or [Exit] and press the () button to confirm.

-  Erased photos/video clips cannot be recovered.
-  Please refer to page 63 for instructions on deleting more than one image at a time.

USING THE MENUS

Shooting Menu

Functions that can be enabled are different under each mode.

Mode:

1. In photo shooting mode, press the button to enter the shooting menu.
2. Press the up/down button to select the shooting menu to be set.
3. Press the left/right button to select the shooting menu to be set and press the button to confirm.



Refer to the following pages for more details about each setting.

Expo Metering

Use this setting to select the "target" size of the camera's field of view to be metered.

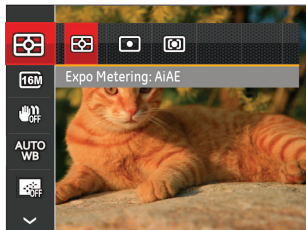

- AiAE (Artificial Intelligence AE)
Automatically selects the central and peripheral metering, to calculate the reasonable value of metering by weighting.
- Spot
For metering targets a small area in the center of the camera's field of view.
- Center
For metering targets a slightly larger area in the center of the cameras field of view.

Image Size

The size setting refers to the image resolution in pixels. A higher image resolution allows you to print that image in larger sizes without degrading the image quality.



The larger the number of recorded pixels, the larger the file size and the fewer files that can be saved on your memory card.

OIS

This mode can help reduce photo blur caused by unintentional hand shake, low light .



-  OIS: Off
-  OIS: On



Use this image stabilization mode in dark environments.









Shooting in a windy or unstable environment (such as a moving vehicle) may cause blurred images.

White Balance Setting

The white balance setting allows you to adjust the color temperature for different lighting sources to ensure the most accurate color reproduction.





-  AUTO WB AWB
-  Daylight
-  Cloudy
-  Fluorescent
-  Fluorescent CWF
-  Incandescent
-  Manual WB (Fully press the shutter button to detect the white balance value)

Cont. AF

Enable the continuous AF to be able to continuously focus automatically when taking pictures.





-  Cont. AF: Off
-  Cont. AF: On

Focus Setting

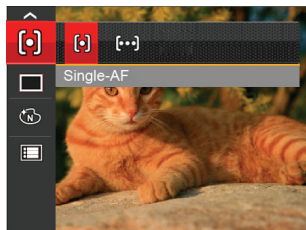
In different photo shooting modes, you can select different focus methods.









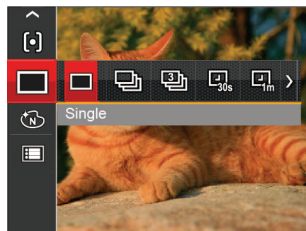

-  Single-AF: The focus frame appears on the center of the LCD to focus on the subject.
-  Multi-AF: The camera automatically focuses the subject in a wide area to find the focus point.

Continuous Shot

Use this setting to perform continuous shooting. After entering this mode, you can shoot multiple images by continuously holding the shutter button down.





-  Single
-  Continuous Shot
-  3 Shots
-  Time-Lapse 30sec
-  Time-Lapse 1min
-  Time-Lapse 5min
-  Time-Lapse 10min





 The flash is disabled in the continuous shooting in order to achieve quick succession of shots.

Color Effect

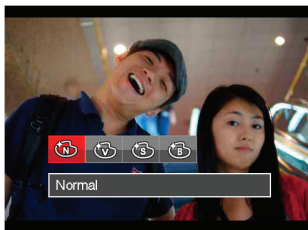









The image color setting allows you to select different effects.

1. In photo shooting mode, press the  button to enter the shooting menu.
2. Press the up/down button to select the image color setting menu, press the  button to enter the menu.
3. Press the left/right button to select the image color setting options.





-  Normal
-  Vivid
-  Sepia
-  Black and White

- Options in the shooting mode (O: Disponible X: Indisponible)





Options	Shooting Modes				
		M			SCN
	O	O	O	X	O
	O	O	O	X	O
	O	O	X	X	X
	O	O	O	X	X
	O	O	O	X	X
	O	O	X	X	X
	X	O	X	X	X
	X	O	X	X	X

Shooting Setting Menu

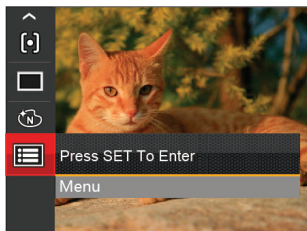
Mode:    **SCN**

1. Press the  button in photo shooting mode and press the up/down button to select .



2. Press the  button to enter the menu.
3. Press the up/down button to select , and press the  button or right button to enter the menu.
4. Press the up/down button to select the item to be set and press the  button or right button to enter the menu.
5. Press the up/down buttons to select an option and press the  button to confirm.

Quality

The quality setting can be used to adjust the image compression ratio.

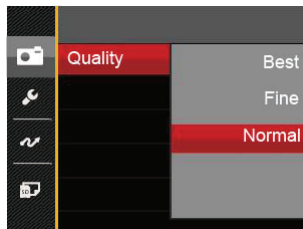

- Best (16M Average File Size: 4.0MB)
- Fine (16M Average File Size: 2.5MB)
- Normal (16M Average File Size: 2.0MB)

AF Assist Beam

In a darker environment, AF assist beam can be turned on for better focus.

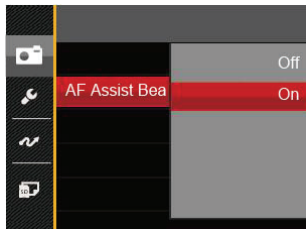

- Off
- On

Digital Zoom

This setting is for adjusting digital zoom. If this function is disabled, only optical zoom can be used.

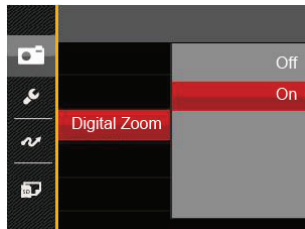

- Off
- On

Date Imprint

Include a Date/Time stamp on the photo image.

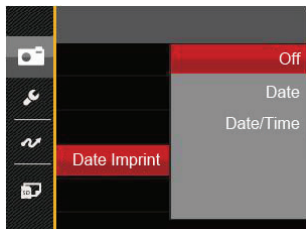

- Off
- Date
- Date / Time

Quick Review

This option allows quick review of the photos immediately after they are taken. Each photo is displayed on the LCD based on the selected time.

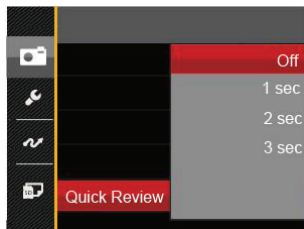

- Off
- 1 sec
- 2 sec
- 3 sec

Face Detection

For detecting and focusing on faces to make all faces as clear as possible in photo mode.

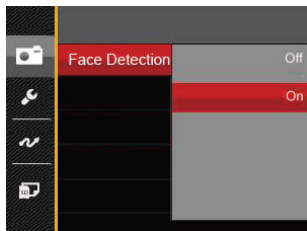

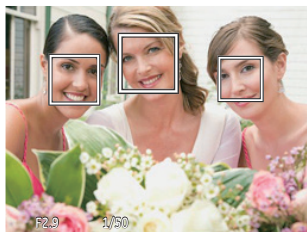

1. Hold the camera steadily and then focus on the object to detect its face. A focus frame will appear at the face on the screen when a face is detected.

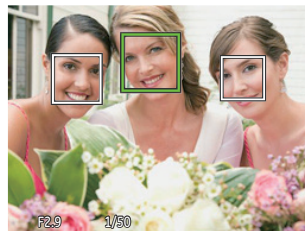

2. Press the shutter button half-way down to focus. The LCD will show a green focus frame when the subject is in focus.





3. Press the shutter button all the way down to take pictures.

 The closed eyes detection is usually on. If the camera detects in the course of quick review there is a face with eyes closed, a prompt of closed eyes will appear .

Movie Menu

Mode: 

1. Press the  button, select the  mode and press the  button to enter the movie menu.





2. Press the up/down button to select the movie menu to be set.
3. Press the left/right button to select the movie menu to be set and press the  button to confirm.

Expo Metering

Use this setting to select the "target" size of the camera's field of view to be metered.



-  AiAE (Artificial Intelligence AE)
Automatically selects the central and peripheral metering, to calculate the reasonable value of metering by weighting.
-  Spot
For metering targets a small area in the center of the camera's field of view.
-  Center
For metering targets a slightly larger area in the center of the cameras field of view.

Video Quality

Set the image resolution used during video recording.

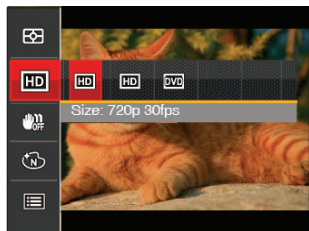

The speed requirements for reading and writing high image pixel images to SD card are as follows:

No.	Image Pixel	Frame	Recommendation	Recording time (4GB) About
1	1280x720 *	30	Class 4	19 minutes
2	1280x720	15	Class 4	37 minutes
3	640x480	30	Class 4	33 minutes



* The longest recording time is 29 minutes at one time.



When recording in higher pixel resolutions for extended periods of time, this can cause the camera to generate heat. This is not a camera malfunction.

OIS

This mode can help reduce images blur caused by unintentional hand shake, low light .



-  OIS: Off
-  OIS: On

 Use this image stabilization mode in dark environments.





 Shooting in a windy or unstable environment (such as a moving vehicle) may cause blurred images.

Color Effect

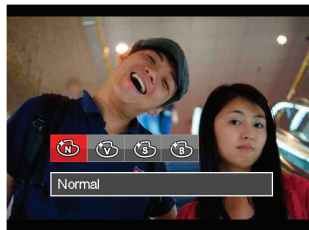
The image color setting allows you to select different effects.





1. Press the  button to select the Image color setting menu.
2. Press the left/right button to select the image color setting options.







-  Normal
-  Vivid
-  Sepia
-  Black and White

Movie Setting Menu

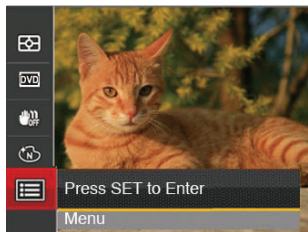
Mode: 

1. Press the  button, and select  to enter the video recording screen.
2. Press the , press the up/down button to select , and press the  button to enter the menu.



3. Press the up/down button to select , and press the  button or right button to enter the menu.
4. Select the items to be set and press the  button or the right button to enter the menu.
5. Press the up/down buttons to select an option and press the  button to confirm.

Digital Zoom



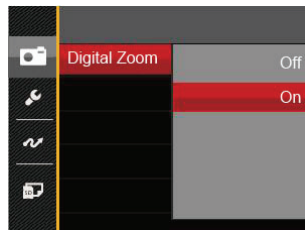

This setting is for adjusting digital zoom. If this function is disabled, only optical zoom can be used.



- Off
- On

Playback Menu

Mode: 

1. Press the  button to display the playback screen and press the  button to enter the menu.
2. Press the up/down button to select the playback to be set and press the  button to enter.
3. Press the left/right buttons to select an option and press the  button to confirm.





Refer to the following pages for more details about each setting.

HDR

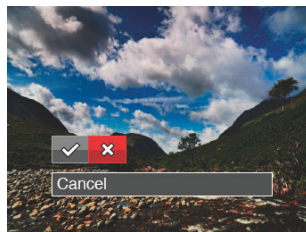
With the HDR function, pictures that are overexposed may be corrected to optimize the highlights and lowlights captured to more accurately represent the actual scene.





-  : HDR
-  : Cancel

 After using the HDR function, the image will be saved as a new file and the original file is still stored in the memory.

Red-Eye Reduction

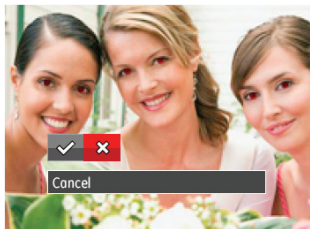
You can use this setting to reduce the Red-Eye of the picture.





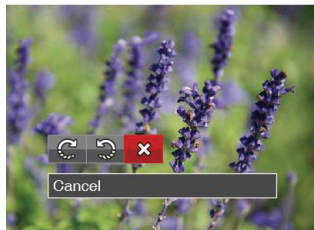

-  : Red-Eye Reduction
-  : Cancel

Rotate

You can use this setting to change the orientation of the picture.



-  : Turn Right
-  : Turn Left
-  : Cancel

-  Videos and panoramic pictures cannot be rotated.
-  The rotated picture file will replace the original photo.

Resize

This setting allows you to resize a picture to a particular resolution and saves it as a new picture.

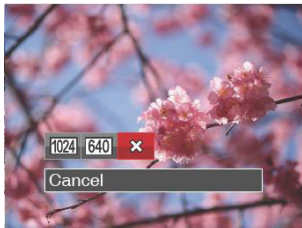

1024 : Resize to 1024x768

640 : Resize to 640x480

 : Cancel



Only for adjusting pictures with high resolution to those with low resolution.

Color Effect

This setting allows you to change the picture color effect. The file is saved as a new photo and stored in memory together with the original photo.

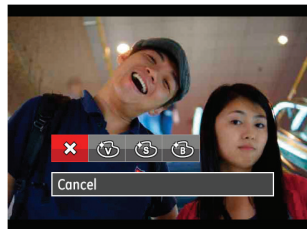

 : Cancel





 : Vivid

 : Sepia



 : Black and White

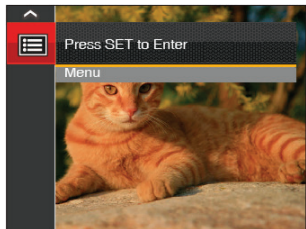

Playback Setting Menu

Mode: 

1. Press the  button to show the playback screen, press the , and press the up/down button to select .
2. Press the  button to enter the menu.



3. Press the up/down button to select , and press the  button or right button to enter the menu.

4. Press the up/down button to select the item to be set and press the  button or right button to enter the menu.
5. Press the up/down buttons to select an option and press the  button to confirm.

Refer to the following pages for more details about each setting.

Protect

To prevent any pictures or videos from being accidentally erased, use this setting to lock one or all of the files.

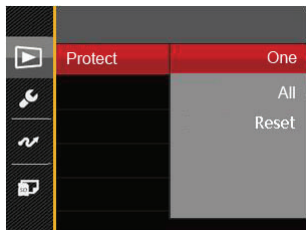

- One: Lock the selected photo or video if they are unprotected; unlock the selected photo or video if they are protected.
- All: Lock all photos or videos.
- Reset: Cancel all locked photos or videos.

Delete

You can delete one or all photo/video files.

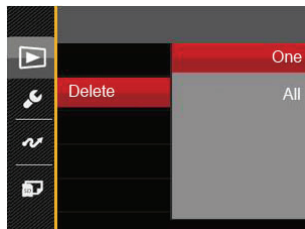

- One: Delete one photo or video.
- All: Delete all photos or videos.

 The "🔒" indicator means a file is protected. File protection must be removed first before a file can be deleted.

 Deleting files will cause DPOF settings to be reset.

DPOF (Digital Print Order Format)

The DPOF feature allows you to compile and select a group of pictures that you would like to print and will save your selection on the memory card so that you can use the SD memory card to print without having to individually specify the photos you want to print.

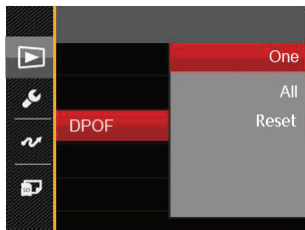

The printer that supports DPOF is needed for printing.

Trim

The Trim Setting allows you to crop photos and save them as new pictures.

1. Select [Yes] to confirm trim. Select a part to be trimmed using the zoom lever and direction buttons to trim a photo.

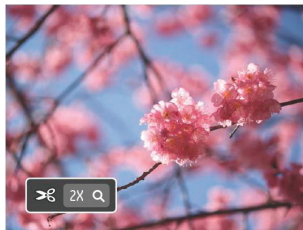







2. Press the **(SET)** button and the [Save change?] prompt appears. Select [✓] to change and save the picture. Select [✗] to cancel changes and return to the trim prompt screen.



The image cannot be clipped/trimmed again once it has been clipped to 640X480.

Setup Menu

Mode :      

1. Press the  button in any mode and press the up/down button to select .
2. Press the  button to enter the menu.
3. Press the up/down button to select , and press the  button or right button to enter the menu.
4. Press the up/down button to select the item to be set and press the  button or right button to enter the menu.
5. Press the up/down buttons to select an option and press the  button to confirm.

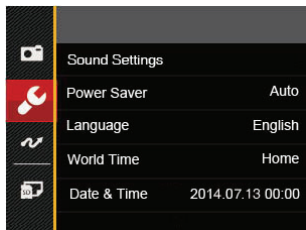

Refer to the following pages for more details about each setting.

Sound Settings

With this setting you may adjust the sound volume. Press the left/right button to adjust the volume and Press the **SET** button to confirm.

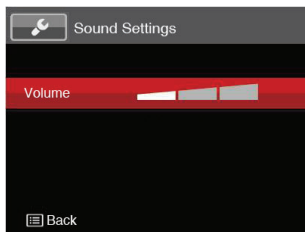

Power Saver

This setting allows you to save power and get the maximum possible running time for your camera's batteries. Turn the LCD and camera off automatically after a consecutive period of inactivity.

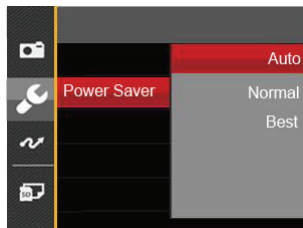

- Auto
- Normal
- Best



Power Saver	LCD power off time	Turn off time
Auto	3 min	5 min
Normal	1 min	3 min
Best	30 s	1 min

Language

Refer to the “Resetting your language” section on page 20.

World Time

The world time setting is a useful function for your overseas trips. This feature enables you to display the local time on the LCD while you are abroad.

1. Press the up/down to select the departure place () and destination () fields.
2. Press the left/right button to select a city located in the same time zone as that of the field. Press the  button to confirm settings.

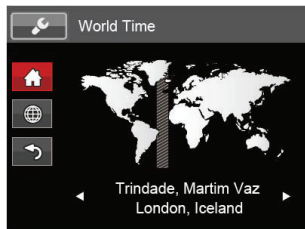

Date & Time

Refer to the “Resetting Date/Time” section on page 21.

LCD Brightness

Use this setting to adjust the brightness of your LCD.

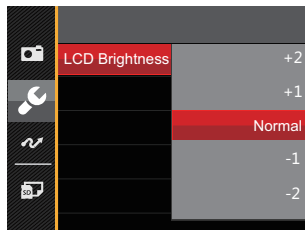

File Setting

Mode : M

1. Press the button, press the up/down button to select and press the button to enter the menu.
2. Press the up/down button to select and press the button or right button to enter the menu.

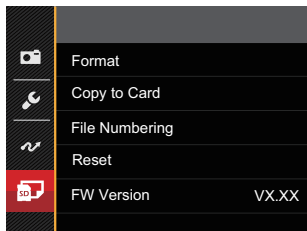

4. Press the up/down button to select the item to be set and press the button or right button to enter the menu.
5. Press the up/down buttons to select an option and press the button to confirm.

Format

Please note: formatting enables you to delete all contents in the memory card and built-in memory, including protected photo and movie files.

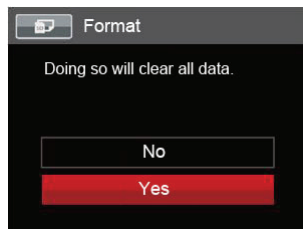

- If you select 「Yes」 the camera formats its memory.
- If there is no memory card in the camera, the built-in memory will be formatted; if there is a memory card, it will be formatted only.

Copy to Card

Use this setting to copy the files stored in the built-in memory to a memory card.

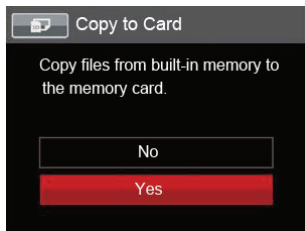

File Numbering

After you take a picture or video clip, the camera will save it with a sequential number. You can use this to reset the file numbering to 1.

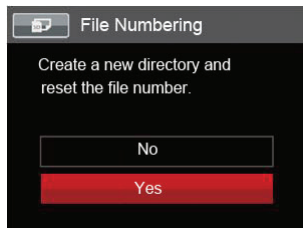

If there is no card available in the camera, this function will not be displayed.

Reset

Use this setting to restore the camera to its original default settings.

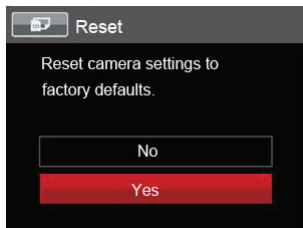

FW Version

Use this setting to view the current camera firmware version.



When there is a new firmware version in the SD card, select [Yes] to update.

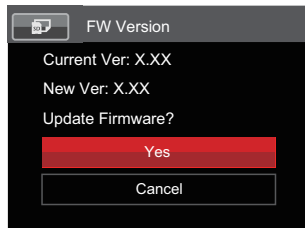







CONNECTIONS

Connecting to a Computer

You can use a Micro USB cable to connect the camera and copy (transmit) photos to a computer, printer or other device.

Setting the USB Mode

The camera's Micro USB port can be set to connect with either a computer or a printer. The following steps will allow you to ensure that the camera is correctly configured to connect with a PC.

1. Press the  button, press the up/down button to select  and press the  button to enter the menu.
2. Press the up/down button to select  and press the  button or right button to enter the menu.
3. Press the up/down button to select [USB] and press the  button or right button to enter the menu.
4. Press the up/down buttons to select [PC] and press the  button to confirm.



Transferring files to your computer

The computer will automatically detect the camera as a removable drive. Double-click the my computer icon on the desktop to locate the removable drive and to copy folders and files in the drive to a directory on your PC as you would copy any typical folder or file.

Follow the steps below to connect the camera to a computer.

1. Make sure both the camera and computer are turned on.
2. Connect one end of the supplied Micro USB cable to the USB Micro port on your camera.
3. Connect the other end of the cable to an available USB port on your computer.
4. After the transmission is complete, disconnect the Micro USB cable according to the instructions specifying how to safely remove USB devices.

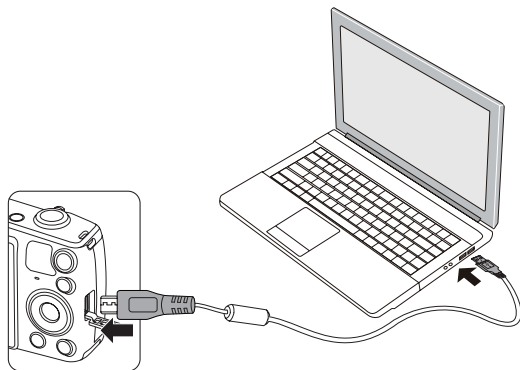

Connecting to a PictBridge Compatible Printer









PictBridge technology allows printing of the photos saved in the memory card by the printer.

To find out if a printer is PictBridge compatible, simply look for the PictBridge



logo on the packaging or check the owner's manual for specifications. With the PictBridge function on your camera, you can print the captured photos directly to a PictBridge compatible printer using the supplied USB cable, without the need for a PC.

Setting the USB Mode

The camera's USB port can be set to connect with either a PC or a Printer, the following steps will ensure that the camera is correctly configured to connect with a Printer.

1. Press the  button, press the up/down button to select  and press the  button to enter the menu.
2. Press up/down button to select  and press the  button or right button to enter the menu.
3. Press the up/down button to select [USB] and press the  button or right button to enter the menu.
4. Press the up/down button to select [Printer] and press the  button to confirm.



-  After the camera is reset, it will switch to PC mode automatically from USB mode.
-  See "Using the PictBridge Menu" section on page 75.

Connecting to your Printer

1. Make sure both the camera and printer are turned on.
2. Connect one end of the supplied Micro USB cable to the Micro USB port on your camera.
3. Connect the other end of the cable to the USB port on the printer.

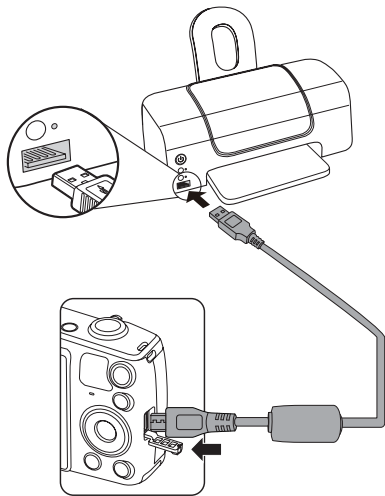

If the camera is not connected to a PictBridge compatible printer, the following error message will appear on the LCD.

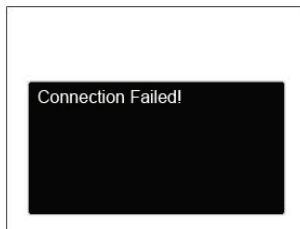

-  The error message above will also appear if the USB mode is set incorrectly, in which case you should disconnect the USB cable, check the USB mode settings, ensure that the Printer is turned on, and then try connecting the USB cable again.

Using the PictBridge Menu

After setting the USB mode to Printer, the PictBridge menu will appear.



Press the up/down button to select a menu item and press the **(SET)** button or right button to enter the item.

Refer to the following sections for more detailed information on each setting.

Print (with Date)

If you have set the date and time on your camera, the date and time will be recorded and saved with each photo you take.

1. In the PictBridge menu, select [Print (with Date)] and the screen as shown below appears.

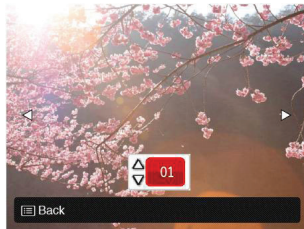

2. Press the left/right button to select a photo to be printed.

3. Press the up/down button to select the number of copies for the currently displayed photo.
4. Press the **SET** button and the following screen will appear.

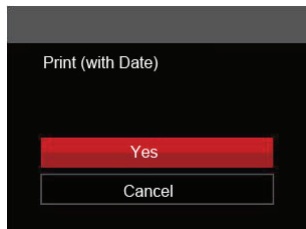

5. Select 「Yes」 and press the **SET** button to confirm; select 「Cancel」 to cancel printing.

Print (without Date)

Use this setting to print the photos without dates on them.

1. In the PictBridge menu, select 「Print (without Date)」 and the screen as shown below appears.

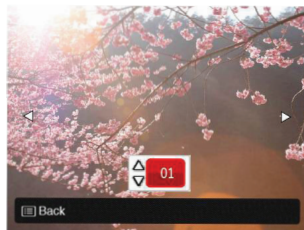

2. Press the left/right button to select a photo to be printed.
3. Press the up/down button to select the number of copies for the currently displayed photo.
4. Press the **SET** button and the following screen will appear.

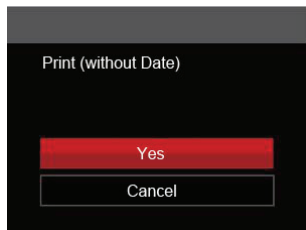

5. Select [Yes] and press the **(SET)** button to confirm; select [Cancel] to cancel printing.

Print Index

You can print all photos in the camera via this function.

1. In the PictBridge menu, select [Print Index] and the screen as shown below appears.

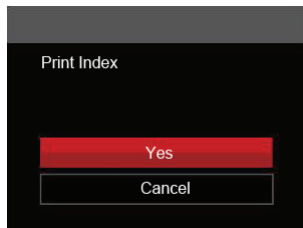

2. Select [Yes] and press the **(SET)** button to confirm; select [Cancel] to cancel printing.

Print DPOF Images

To use DPOF printing, you must select your photos for printing using the DPOF settings beforehand. See “DPOF” section on page 64.

1. In the PictBridge menu, select [Print DPOF Images] and the screen as shown below appears.

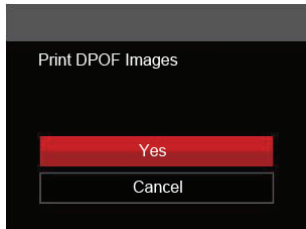

2. Select [Yes] and press the **SET** button to confirm; select [Cancel] to cancel printing.

Exit







Select [Exit] to exit the PictBridge menu. At this time, the message [Remove USB Cable!] appears on the screen.



Disconnect the USB cable from the camera and printer.

Video System

Use this feature to switch the video system from either NTSC or PAL.

1. Press the  button, press the up/down button to select  and press the  button to enter the menu.
2. Press the up/down button to select  and press the  button or right button to enter the menu.
3. Press the up/down button to select [TV-System] and press the  button or right button to enter the menu.
4. Press the up/down button to select [NTSC] or [PAL] and press the  button to confirm.

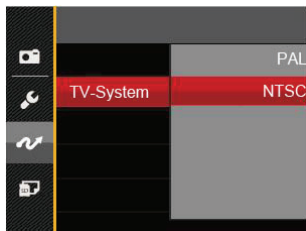

NTSC: English, Chinese (Traditional), Japanese, French, Korean, Russian, Vietnamese, Greek, Hungarian







PAL: German, Spanish, Italian, Chinese (Simplified), Portuguese, Swedish, Danish, Finnish, Indonesia, Norwegian, Dutch, Turkish, Polish, Thai, Croatian, Czech, Arabic, Hindi



The video output system would change accordingly based upon the changes of the selected language.

Set Eye-Fi SD Card Connection Mode

This camera supports wireless connection for Eye-Fi memory cards. Enable the Eye-Fi connection by following the steps below.

1. Press the  button, press the up/down button to select  and press the  button to enter the menu.
2. Press the up/down button to select  and press the  button or right button to enter the menu.
3. Press the up/down button to select 「Eye-Fi」 and press the  button or right button to enter the menu.
4. Press the up/down buttons to select 「On」 or 「Off」 and press the  button to confirm.

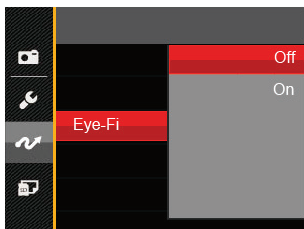

If the Eye-Fi card is not available in the camera, this feature is not displayed.

APPENDICES

Specifications



Design and specifications are subject to change without notice.

Image Sensor	Type	1/2.3"CCD
	Effective Pixels	16.15 Megapixels
	Total Pixels	16.44 Megapixels
Lens	Focal Length	4.5mm (Wide) — 90.0mm (Tele)
	35mm film equivalent	25mm (Wide) — 500mm (Tele)]
	F number	F3.5 (Wide) — F4.9 (Tele)
	Lens Construction	9 groups 11 elements
	Optical Zoom	20x
	Focusing Range	Normal: (Wide) 60cm ~ ∞ (Tele) 200cm ~ ∞ Macro: 3cm ~ ∞ (Wide Only)
Autofocus System		TTL Autofocus
Anti-Handshake		Optical Image Stabilization
Digital Zoom		4x Digital Zoom (Combined Zoom: 80x)

Number of Recording Pixels	Still Image	(4:3) 16MP: 4608×3456 10MP: 3648×2736 5MP: 2592×1944 3MP: 2048×1536 0.3MP: 640×480	(3:2) 14MP: 4608×3072	(16:9) 12MP: 4608×2592 2MP: 1920×1080
	Movie	1280×720(15/30fps), 640×480(30fps)		
Image Compression		Best, Fine, Normal		
DCF, DPOF (Ver1.1) Support		Yes		
File Format	Still Image	Exif 2.3 (JPEG)		
	Movie	MOV [Image: Motion JPEG; Audio: G.711(Monaural)]		
Shooting Modes		Auto Mode, Manual Mode, Portrait, Movie Mode, Panorama Mode, Scene Mode		
Scene Mode		ASCN Scene, Landscape, Sport, Beach, Sunset, Fireworks, Night Landscape, Snow, Children, ID, Glass, Photo Frame, Panning Shot, Night Portrait, Fish Eye, Party, Indoor, Leaf, Museum , Night Portrait, Sketch		
Detection Features		Face, Smile, Blink		
Red-Eye Removal		Yes		
HDR		Yes(Post-Processing)		

Panorama	Up to 180° (Horizontal)
LCD Display	3.0inch (230k Pixels)
Image Auto Rotation	Yes
ISO Sensitivity	Auto, ISO80/100/200/400/800/1600
AF Method	Single AF, Multi-AF (TTL 9-point), Face-Detection
Exposure Metering Method	Artificial Intelligence AE (AiAE), Center-Weighted Average, Spot (Fixed to Center of Frame), Face AE
Exposure Control Method	Program AE (AE-Lock Available)
Exposure Compensation	±2EV in 1/3 Step Increments
Shutter Speed	1/2000 - 4 Seconds (Manual: 30 Seconds)
Continuous Shooting	Yes
Playback Modes	Single Photo, Index (9/16 Thumbnails), Slide Show
	Zoom (Approx. x2-x8)
White Balance Control	AWB, Daylight, Cloudy, Fluorescent, Fluorescent CWF, Incandescent, Manual

Flash	Flash Method	Pop-up (Manual)
	Flash Modes	Force Off, Flash Auto, Red-Eye Reduction, Fill Flash, Slow Synchro, Red-Eye Reduction + Slow Synchro
Recording Media		Internal Memory: Approx. 8MB
		SD/SDHC Card (Up to 32GB Support) (MMC Card Not support)
PictBridge, ExifPrint Support		Yes
Multi-Language Support		27 Languages
Jacks		AV-OUT/USB 2.0 (Micro 5 pin USB)
Eye-Fi Support		Yes
Power		Rechargeable Li-ion Battery LB-052, 3.7V 880mAh, In-Camera Charging
Shooting Capability (Battery Performance)		Approx. 210 Shots (Based on CIPA Standards)
Operation Environment		Temperature: 0 - 40°C, Humidity: 0 - 90%
Dimensions (W×H×D)		Approx. 109.7×69.6×38.3mm (Based on CIPA Standards)
Weight		Approx. 202 g (Body Only)

Prompts and Warning Messages

Message	Description	Action
Warning! Battery exhausted.	The camera battery is used up. It is a warning indicating that the camera is going to shut down.	Replace with new batteries. The camera will shut down in 2 seconds.
Lens obstruction, Re-start Camera.	The lens is jammed or some foreign object is preventing the lens from functioning properly.	Turn off the camera and restart it to reset the lens.
Suggest using tripod.	When continuous exposure is enabled, this prompt message is displayed when the photo shooting screen is displayed for the first time.	The message will disappear after 2 seconds
Built-in memory error!	An error occurs in internal memory.	The message will disappear after 2 seconds
Slow shutter is on: may easily cause overexposure.	When the B shutter is on, the prompt appears on the screen after you go back to the photo shooting screen.	The message will disappear after 2 seconds.
Improper alignment. Please try again.	The offset is too big for panorama shooting.	The message will disappear after 2 seconds.

Message	Description	Action
Connection Failed!	In the case of failing to connect to a PC or a printer.	Remove transmission line to stop connection, and the message is removed.
Warning! Do not turn off your camera during update!	The message appears during the firmware update process.	The message disappears after the camera update and restart.
Remove USB Cable !	Indicates that you can disconnect the Micro USB cable.	The message disappears after you disconnect the Micro USB cable.
Write Protect !	When you boot, press the shutter button or edit the files under playback mode, and the SD card is locked, the message appear.	The message will disappear after 2 seconds.
Card Full !	When you boot, press the shutter button or edit the files under playback mode, and the SD card is locked, the message appear.	The message will disappear after 2 seconds.
Memory Full !	When you boot, press the shutter button or edit the files under playback mode, and the SD card is locked, the message appear.	The message will disappear after 2 seconds.

Message	Description	Action
Card Error !	The card cannot be recognized after being formatted.	Normal display.
Card is not formatted.	When an error occurs in the SD card, the message "Not Formatted" appears.	Disappear after 2 seconds and enter the formatting process.
Slow access	When a SD card lower than Class 4 is used to record a HD movie, the writing speed will be slower and recording will not continue.	Remove the message after 2 seconds and return to the shooting image.
Cannot write to SD card.	The photo shooting or video recording has been interrupted so recording cannot continue.	Remove the message after 2 seconds and return to the shooting image.
No Red-Eye Detected!	No red-eye detected when pressing for red-eye removing in playback touch-up.	The message will disappear after 2 seconds.

Message	Description	Action
This image cannot be edited.	The file format does not support editing or the edited file cannot be edited again.	The message will disappear after 2 seconds.
Exceeded maximum folder number.	This indicates that the SD card exceeded the maximum number of folders (999). This could cause a long read time during the camera's power up.	The message will end after the camera processing is complete.
Too many pictures for quick processing.	During the playback by date, the images exceed specifications so that it is not possible to play by date.	The message disappears after 2 seconds and the camera returns to the normal playback mode.
Unable to recognize files.	The format of the file to be viewed is not supported or the file is corrupted so it cannot be properly read.	This image message disappears only after the file is deleted.
No Picture!	When you press the play button, no image files exist in the camera or memory card.	The message disappears 2 seconds later to return to the photo shooting screen.
Protected! Undeleteable!	The file is protected. The message appears when you delete it.	The message will disappear after 2 seconds.

Troubleshooting

Problem	Possible causes	Solution
Camera does not turn on	<ul style="list-style-type: none"> ■ The battery has been depleted. ■ The battery is not inserted correctly. 	<ul style="list-style-type: none"> ■ Recharge the battery. ■ Correctly reinstall the battery.
Camera turns off suddenly during operation	<ul style="list-style-type: none"> ■ The batteries have been depleted. 	<ul style="list-style-type: none"> ■ Recharge the battery.
The picture is blurred	<ul style="list-style-type: none"> ■ Camera shakes while taking a picture. 	<ul style="list-style-type: none"> ■ Turn on OIS feature. ■ Please use tripod for high magnification (above 15X) optical zoom.
Images and video files cannot be saved	<ul style="list-style-type: none"> ■ The SD memory card is full. ■ The memory card is locked. 	<ul style="list-style-type: none"> ■ Use another memory card or delete unnecessary files. ■ Unlock the memory card.
Images will not print from the connected printer	<ul style="list-style-type: none"> ■ The camera is not connected to the printer correctly. ■ The printer is not PictBridge compatible. ■ The printer is out of paper or ink. ■ The printer paper is jammed. 	<ul style="list-style-type: none"> ■ Check the connection between the camera and printer. ■ Use a PictBridge compatible printer. ■ Load paper into the printer or replace the ink cartridge in the printer. ■ Remove the jammed paper.

Problem	Possible Causes	Solution
Saving data to memory card is slow	<ul style="list-style-type: none"> ■ Using a memory card below Class 4 may result in slower recording times. 	<ul style="list-style-type: none"> ■ Use a memory card with write Class 4 or higher than 4 to improve performance.
Cannot write to the memory card	<ul style="list-style-type: none"> ■ The SD memory card has been locked. 	<ul style="list-style-type: none"> ■ Release the write lock of the memory card or replace with another card.
Too many movies to process	<ul style="list-style-type: none"> ■ The number of pictures or folders in the memory card exceed the specifications, so the playback of data folder can not be displayed. 	<ul style="list-style-type: none"> ■ Delete unwanted files.
The flash  flashes on the LCD screen.	<ul style="list-style-type: none"> ■ Current shooting environment requires flash. 	<ul style="list-style-type: none"> ■ Turn on flash.



The Kodak trademark and trade dress are used under license from Kodak.

© 2014 by JK Imaging Ltd. All Rights Reserved.

JK Imaging Ltd., 17239 South Main Street, Gardena, CA 90248, USA

JK Imaging Europe, 71 Clarendon road, Watford, WD17 1DS, UK

www.kodakpixpro.com