

KODAK PIXPRO AZ255

DIGITAL CAMERA

User Manual



BEFORE YOU START

Declaration of Conformity

Responsible Party: JK Imaging Ltd.

Address: JK Imaging Ltd., 14067 Stage Road, Santa Fe Springs, CA 90670 USA

Company website: kodakpixpro.com

For Customers in the USA

Tested to Comply with FCC Standards FOR HOME OR OFFICE USE

This device complies with part 15 of the FCC Rules. Operation is subject to the following two conditions:

(1) This device may not cause harmful interference and (2) this device must accept any interference received, including interference that may cause undesired camera operation.

For Customers in Europe

 "CE" mark indicates that this product complies with the European requirements for safety, health, environment and customer protection. "CE" marked cameras are intended for sales in Europe.

 This symbol [crossed-out wheel bin WEEE Annex IV] indicates separate collection of electrical waste and electronic equipment in the European countries. Please do not throw the equipment into domestic refuse. Please use the return and collection systems available in your country for proper, safe disposal of this product.

 Batteries: Please dispose of used batteries at designated collection centers.

 Packaging: Please follow local regulations for the recycling of packaging.

About this Manual

Thank you for purchasing this KODAK PIXPRO Digital Camera. Please read this manual carefully and keep it in a safe place for future reference.

- JK Imaging Ltd. reserves all rights of this document. No part of this published manual may be reproduced, transmitted, transcribed, stored in a retrieval system or translated into any language or computer language, in any form, by any means, without the prior written permission of JK Imaging Ltd.
- All trademarks mentioned in this manual are used for identification purposes only and are properties of their respective owners.
- This manual provides you with instructions on how to use your new KODAK PIXPRO Digital Camera. Every effort has been made to ensure that the contents of this manual are accurate: however JK Imaging Ltd. reserves the right to make changes without notice.
- Throughout this manual, the following symbols are used to help you locate information quickly and easily:



Indicates useful information.

- The following symbols may be used throughout this manual to facilitate your understanding of how to operate the camera:

[Item properties]: The optional properties in the camera interface are indicated by the [] symbol.

SAFETY NOTES

Safety Notes for this Camera

- Do not drop the camera or allow it to hit solid objects.
- Do not attempt to disassemble or repair the camera.
- Do not use or store the camera in dusty places or on a beach without taking precautions to help prevent dust or sand from entering the camera, causing possible damage.
- Do not use or store the camera in a hot environment or in direct sunlight.
- Do not use or store the camera near powerful magnetic fields, for example near a magnet or transformer.
- Avoid touching the lens of the camera.
- Do not expose the camera to direct sunlight for a long period of time.
- To prevent the camera from being damaged by moisture, do not use or store the camera in very humid environments, such as in rain or near bodies of water.
- If water accidentally comes in contact with the camera, turn the camera off immediately, remove the battery and the memory card and dry it completely within 24 hours.
- When you take the camera from a cold environment to a warmer environment, condensation may occur. Please wait for a reasonable period of time before you turn the camera on and use it.
- Before you remove the battery and memory card, the camera should be turned off.
- When you clean the body of the camera, do not use abrasive, alcohol-based or organic cleansers or solvents.
- Use a professional lens cleaning cloth and appropriate cleaner to wipe and clean the lens.
- Download your photos and remove the memory card when you are going to store the camera for long periods of time.
- If this camera is not in use for a long period of time, please keep it in a dry and clean storage location.
- Our company will not pay compensation for any failure of playback including: pictures or videos damaged or unrecoverable by improper operation.

Safety Notes for Battery

- If battery fluid leaks inside the camera, contact our customer service department immediately. If battery fluid leaks onto your skin, rinse your skin with clean water and seek immediate medical attention.
- Disposal of used batteries should be carried out in accordance with your local (national or regional) regulations.
- To prevent the battery from being damaged, do not drop the battery or allow it to hit solid objects or to be scratched by foreign objects.
- Do not let the battery come in contact with metal objects (including coins) to avoid short circuiting, discharging, excessive heat or possible leakage.
- Do not attempt to disassemble the battery.
- Do not expose the battery to water. Always keep the battery contacts dry.
- Do not heat the battery or throw it into a fire to avoid a possible explosion.
- Do not store the battery in a hot environment or in direct sunlight.
- When the camera is stored for a long period of time, remove the battery and keep it in a safe, dry place that is not accessible to infants and children.
- In colder environments, the performance of the battery could be noticeably reduced.
- When you install the battery, align the battery markings according to the positive and negative markings inside the camera battery compartment. Never force the battery into the battery compartment.

Safety Notes for Memory Cards

- We highly suggest buying only well-known, name brand memory cards to ensure peak performance and reliability.
- Format the memory card using the camera before you use it or insert a new one.
- Do not drop the memory card or allow it to hit solid objects to avoid damaging it.
- Do not attempt to disassemble or repair the memory card.
- Do not expose the memory card to water. Always keep it dry.
- Do not remove the memory card when the camera is turned on. Otherwise, the memory card and photo / video files could be permanently damaged.
- Do not directly edit the data on the memory card. Copy the data to your computer before you edit files.
- When the camera is stored for long periods of time, be sure to download your photos and remove the memory card. Store the memory card in a dry environment.
- Do not modify the name of the files or folders of the memory card using your computer. Modifying the file names may cause the files to not be recognized on the camera or a possible permanent error may occur.
- A photo taken with the camera will be stored in the folder that is automatically generated on the memory card. Do not store photos that are not taken using this camera in these folders as the pictures cannot be recognized during playback.
- When you insert the memory card, make sure the notch of the card matches the markings on the top of the camera card slot.

Other Safety Notes

- Do not disconnect the power or turn the camera off during the update process. Doing so may cause incorrect data to be written and the camera may not power on later.
- Do not hang the neck or wrist strap of the camera around the neck of a child.
- When using your camera on an airplane, observe the relevant rules specified by the airline and FAA regulations.
- Due to the limitations of manufacturing technology, the LCD may have a few dead or bright pixels. These pixels do no effect the quality or performance of the camera, photos or video.
- Do not expose the camera's LCD to water. In a humid environment, only wipe it with a soft, dry and cleaning cloth.
- If the LCD is damaged and the liquid crystal comes into contact with your skin, wipe your skin with a dry cloth immediately and rinse it with clean water. If liquid crystal comes into contact with your eyes, wash them with clean water at least for 15 minutes and seek immediate medical attention. If you accidentally swallow liquid crystal, rinse your mouth immediately and seek medical attention.

WARNING

- Altering, tampering or modifying the any parts of AZ255 camera is unauthorized and will void the manufacturer's warranty and "could" void Federal and/or State Compliance.
- This equipment has been tested and found to comply with the limits for a Class B digital device, pursuant to part 15 of the FCC Rules. These limits are designed to provide reasonable protection against harmful interference in a residential installation.

This equipment generates, uses, and can radiate radio frequency energy and, if not installed and used in accordance with the instructions, may cause harmful interference to radio communications. However, there is no guarantee that interference will not occur in a particular installation.

If this camera equipment does cause harmful interference to radio or television reception, which can be determined by turning the equipment off and on, the user is encouraged to try to correct the interference by one or more of the following measures:

- Reorient or relocate the receiving antenna
- Increase the separation between the camera equipment and receiver
- Connect the camera equipment into an outlet on a circuit different from that to which the receiver is connected
- Consult the dealer or an experienced radio / TV technician for help

CONTENTS

BEFORE YOU START 1

SAFETY NOTES 3

CONTENTS 8

GETTING STARTED 12

Accessories Included 12

Installing Lens Cap and Neck Strap 13

Part Names 14

Installing AA Batteries and Memory Card 15

Turning Camera On and Off 17

How to Take Pictures 18

Set your Language, Date / Time 18

Set your Language, Date / Time after the
First Power-On 18

Resetting your Language 19

Resetting Date/Time 20

MODE OVERVIEW 21

Display Setting 21

LCD Screen Display 22

Overview of the Screen Icons in Photo
Shooting Mode 22

Overview of the Screen Icons in Movie
Mode 23

Overview of the Screen Icons in
Playback Mode 24

Using the Mode Dial 25

Auto Mode  25



Program AE **P** 25

Shutter Priority **S** 25

Aperture Priority **A** 26

Manual Mode **M** 26

Face Beautifier  26

Panorama Mode 	27
Scene Mode SCN	28
Movie Mode 	31
Custom Settings CS	31

BASIC OPERATION..... 33

Using the Zoom Function.....	33
Focus Setting.....	34
Macro Mode.....	35
Self-Timer Setting.....	36
Flash Mode	37
White Balance Setting.....	39
Continuous Shot	40
EV Setting	41
Exposure Compensation	41
ISO	41
Shutter Adjustment.....	42







Aperture Adjustment	42
Using Quick Recording	42
Color Setting	43









PLAYBACK 45



Viewing Photos and Videos	45
Thumbnail View.....	46
Using Zoom Playback (for still pictures only) .	48
Slideshow	49
Animation Panorama Playback	50
Photos and Video Deletion	51

USING THE MENUS..... 52

Photo Menu	52
Expo Metering (Exposure Metering) 	52
Image Size 16M	53
Continuous AF 	53

OIS (Optical Image Stabilization)  OFF	54
HDR (High Dynamic Range) 	54
Face Beautifier 	55
Scene 	55
Photo Shoot Settings Menu 	56
Quality	56
AF Assist Beam	57
Digital Zoom	57
Date Imprint	58
Quick Review	58
Custom Settings	59
Face Detection	59
Movie Menu	60
Expo Metering (Exposure Metering) 	60
Video Quality 	61

OIS (Optical Image Stabilization)  OFF	62
Movie Shooting Settings Menu 	62
AF Assist Beam	63
Digital Zoom	63
Custom Settings	63
Playback Menu	65
Display Mode 	65
HDR (High Dynamic Range) 	66
Touch-up 	66
Rotate 	67
Resize 	67
Color	68
Playback Settings Menu 	69
Protect	69
Delete	70
DPOF (Digital Print Order Format)	71

Trim.....	71
General Settings 	72
Sound Settings.....	73
Power Saver.....	73
Language.....	74
World Time	74
Date & Time	74
LCD Brightness.....	74
Connection Settings 	75
Connecting to a Computer	76
Transferring Files to Your Computer	76
File Settings 	77
Format	78
Copy to Card.....	78
File Numbering.....	79
Reset.....	79
Firmware (FW) Version	79

APPENDICES	80
Specifications.....	80
Prompts and Warning Messages	84
Troubleshooting	88
Memory Card Compatibility	89

GETTING STARTED

Accessories Included

Your camera box should contain the camera model you purchased along with the following accessories. If anything is missing or appears to be damaged, please contact your retailer first or our customer service center.

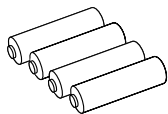

*AA Alkaline 'Starter'
Battery x4

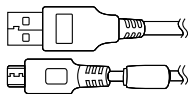

Micro USB Cable



Neck Strap



Lens Cap with Cord



Quick Start Guide



Warranty Card



Service Card





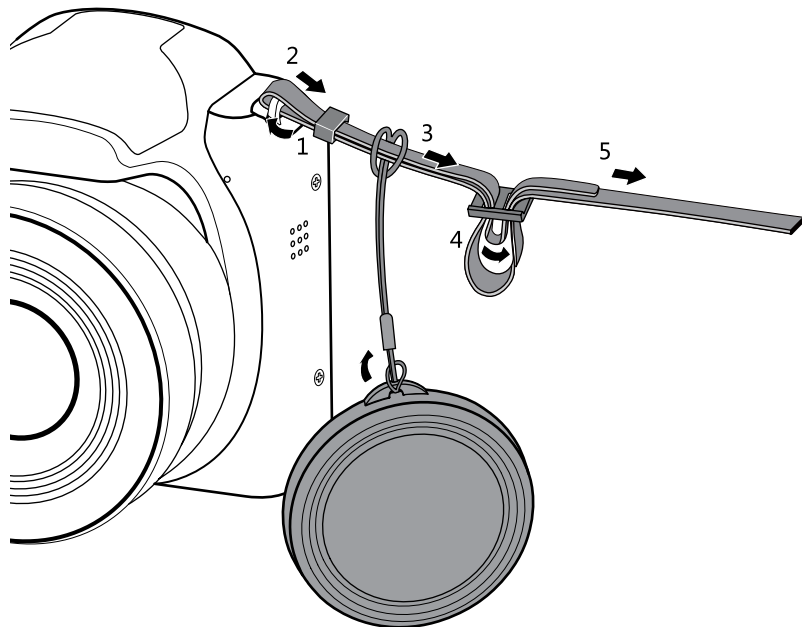



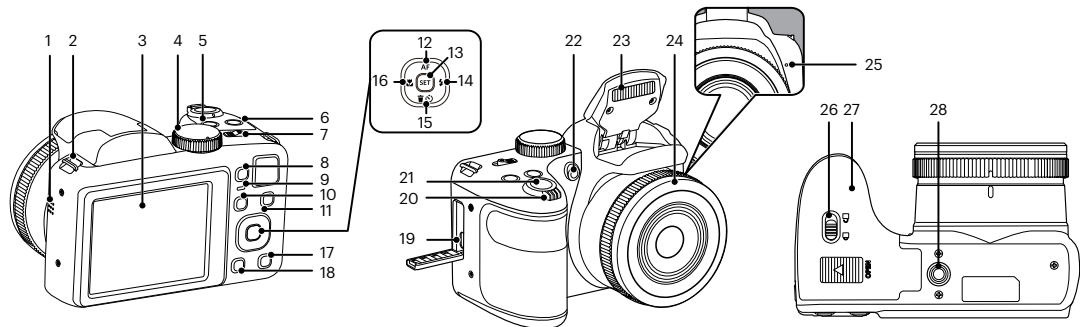



 * The AA Alkaline 'Starter' batteries are intended to allow you to test and set up your new camera. We highly recommend purchasing name brand, top tier AA batteries for best performance and to keep extra batteries on hand to swap out when needed.

Installing Lens Cap and Neck Strap



Part Names





- | | | |
|--|--|-------------------------------------|
| 1 Speaker | 11  Menu Button | 20 Zoom Lever |
| 2 Strap Eyelet | 12 [ AF] AF Button / Arrow Button (Up) | 21 Shutter Button |
| 3 LCD | 13  SET Button | 22 AF Assist Beam / Self-Timer Lamp |
| 4 Mode Dial | 14 [] Flash Button / Arrow Button (Right) | 23 Flash Lamp |
| 5  Continuous Shot Button | 15 [ ] Delete Button / Self-Timer Button / Arrow Button (Down) | 24 Lens |
| 6  Exposure Compensation Button | 16 [] Macro Button / Arrow Button (Left) | 25 Microphone |
| 7 Power Switch | 17  Display Button | 26 Battery Cover Lock |
| 8  Fast Video Recording Button | 18  Playback Button | 27 Battery Door Cover |
| 9 Indicator Lamp | 19 Micro USB Port | 28 Tripod Socket |
| 10  "I" Button | | |

Installing AA Batteries and Memory Card

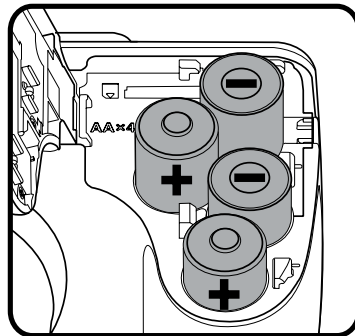
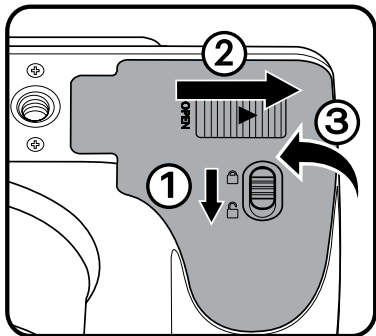
1. Open the battery cover door.
2. Insert 4 AA batteries into the battery slot in the correct direction as shown in the following diagram:



-  Please use brand name batteries (such as Energizer® or Duracell®) for optimal performance. Do not mix new and old batteries or use different brands of batteries. When replacing batteries, please replace all 4 batteries at the same time.
-  The performance and life expectancy of alkaline batteries will vary depending on the brand.
-  Do not mix alkaline, standard (carbon-zinc), or rechargeable (ni-cad, i-mh, etc.) batteries.

3. Insert the memory card into the memory card slot as shown in the diagram below:

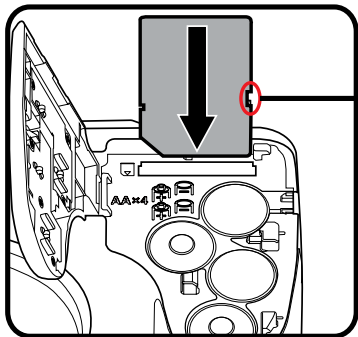

Write Protection
Toggle Switch

4. Close the battery cover door.

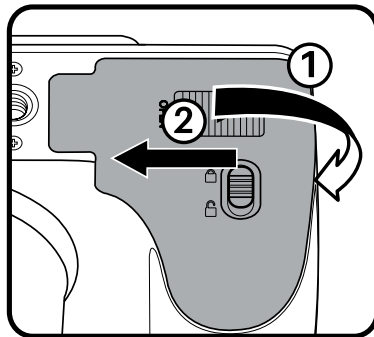

 A memory card (SD / SDHC / SDXC) is necessary to store photos and videos and not included in all camera packaging. It needs to be purchased separately. Please use a memory card which is Class 10 or higher and has a capacity of 4GB to 512GB.



 To remove your memory card, open the battery cover door, gently press the memory card to eject it and remove it carefully.

Turning Camera On and Off

Slide the Power Switch to turn the camera on/off.

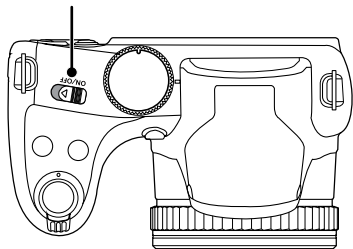
Power Switch



 When the power is off, press and hold the Playback Button  to power on and enter Playback Mode.

How to Take Pictures

1. Hold the camera with both hands, being careful to not block the flash and lens with fingers.
2. Point the Lens toward the object you want to take a picture of, then frame it with the LCD.
3. Use the Zoom Lever to select Tele or Wide positions to zoom in or out on your subject.
4. Press the Shutter Button halfway down to focus on the subject. When the focus frame turns green, press the Shutter Button all the way down completely to take the picture.









Set your Language, Date / Time

Set your Language, Date / Time after the First Power-On

1. When you turn the camera on for the first time, the language selection screen appears.
2. Press the [▲ AF] / [▼ 🗑️ 🌙] / [◀ 📷] / [▶ ⚡] buttons to select your desired language.
3. After you press the (SET) button to confirm your language selection, the Date / Time settings screen will appear.
4. Press the [◀ 📷] / [▶ ⚡] buttons to select the Date / Time to be adjusted: This information is displayed in YYYY.MM.DD / HH:MM.
5. Press the [▲ AF] / [▼ 🗑️ 🌙] buttons to adjust the value for the desired Date / Time.
6. Press the (SET) button to confirm the time settings and the snapshot screen will appear.

Resetting your Language





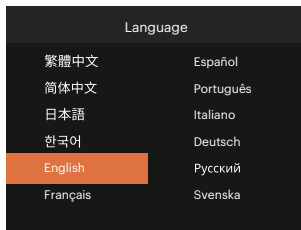
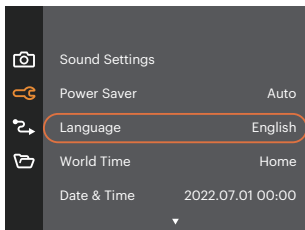

After you set your language for the first time, follow the instructions below to reset your desired language.

1. Press the  button and press the [▲ AF] / [▼ 🗑️ ⌚] buttons to select . Press the  button to enter the menu.
2. Press the [▲ AF] / [▼ 🗑️ ⌚] buttons to select , and press the  / [▶ ⚡] button to enter the menu.
3. Press the [▲ AF] / [▼ 🗑️ ⌚] buttons to select [Language] and press the  / [▶ ⚡] button to enter the menu.
4. Press the [▲ AF] / [▼ 🗑️ ⌚] / [◀ 🗑️] / [▶ ⚡] buttons to select your desired language and press the  button to confirm.
5. Press the  button and the snapshot screen will appear.





Resetting Date/Time

After you set your Date/Time for the first time, follow the instructions below to reset date and time.

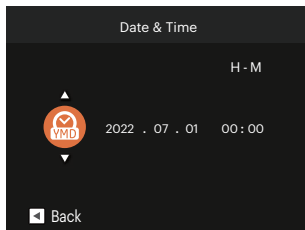
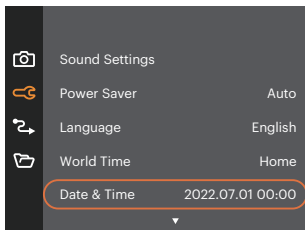
1. Press the  button and press the [▲ AF] / [▼🗑️🕒] buttons to select . Press the  button to enter the menu.
2. Press the [▲ AF] / [▼🗑️🕒] buttons to select , and press the  / [▶⚡] button to enter the menu.
3. Press the [▲ AF] / [▼🗑️🕒] buttons to select [Date & Time] and press the  / [▶⚡] button to enter the menu.



4. Press the [▼🗑️] / [▶⚡] buttons to select the Date/Time to be adjusted: This information is displayed in YYYY.MM.DD/HH:MM.
5. Press the [▲ AF] / [▼🗑️🕒] buttons to press the value for your selected entry. After you finish your settings, press the  button to confirm.
6. Press the  button and the following snapshot screen will appear.

MODE OVERVIEW

Display Setting

Press the **(DISP)** button to display the settings: Classic, Full, Off.

Classic: Displays the camera parameters on screen

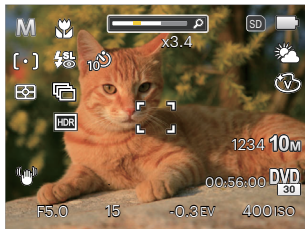

Full: Camera parameters with Grid and Histogram

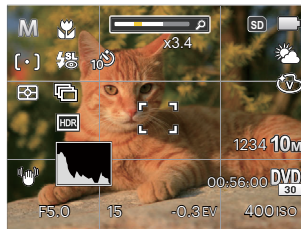

Off: Does not display any additional icons on screen

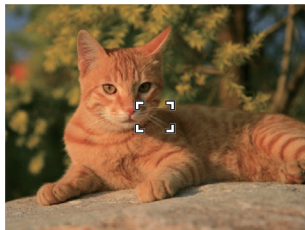

LCD Screen Display

Overview of the Screen Icons in Photo Shooting Mode

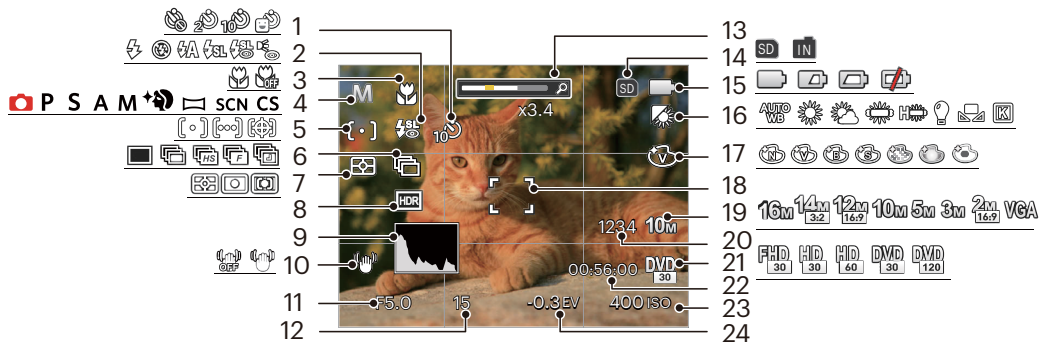

- | | | |
|-------------------|--------------------------------------|-------------------------------------|
| 1 Self-Timer | 9 Histogram | 17 Color Effect |
| 2 Flash Mode | 10 Optical Image Stabilization (OIS) | 18 Focus Frame |
| 3 Macro Mode | 11 Aperture | 19 Image Size |
| 4 Shooting Mode | 12 Shutter Speed | 20 Number of Remaining Shots |
| 5 AF Mode | 13 Zoom Display | 21 Video Quality |
| 6 Continuous Shot | 14 Memory Card / Built-In Memory | 22 Remaining Recording Time |
| 7 Expo Metering | 15 Battery Status | 23 ISO Value |
| 8 HDR | 16 White Balance | 24 Exposure Compensation (EV Value) |

Overview of the Screen Icons in Movie Mode

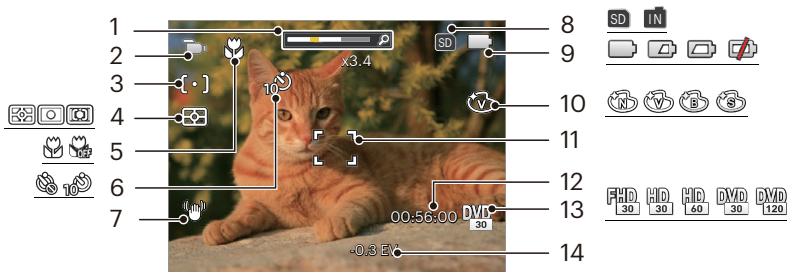

1 Zoom Display

2 Movie Mode

3 Single-AF

4 Expo Metering

5 Macro Mode

6 Self-Timer

7 Optical Image Stabilization (OIS)

8 Memory Card / Built-In Memory

9 Battery Status

10 Color Effect

11 Focus Frame

12 Remaining Recording Time

13 Video Quality

14 Exposure Compensation (EV Value)

 For optimal video recording and more than a couple of test photos, it is recommended that an SDHC or SDXC memory card be used.

 Optical Zoom and Digital Zoom can be adjusted (100X in total). Digital Zoom can be adjusted to 4X.

Overview of the Screen Icons in Playback Mode

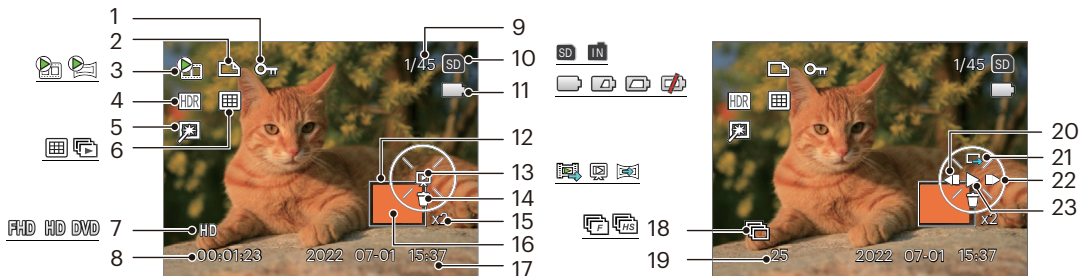

- | | | |
|-------------------------------|---|------------------------------|
| 1 File Protection | 9 Memory Space (indicating the current number of photos and total number of photos) | 17 Shooting Date |
| 2 DPOF File | 10 Memory Card / Built-In Memory | 18 Continuous Shot |
| 3 Movies / Animated panoramas | 11 Battery Status | 19 Number of Photos in Burst |
| 4 HDR | 12 Image Zone | 20 Frame Backward |
| 5 Touch-up | 13 Playback Type | 21 Switch to Single Playback |
| 6 Display Mode | 14 Deletion | 22 Frame Forward |
| 7 Video Quality | 15 Image Zoom Ratios | 23 Play |
| 8 Recording Time | 16 Zoom Magnification Area | |

Using the Mode Dial

This camera provides a convenient Mode dial that allows you to manually switch between different modes with ease.

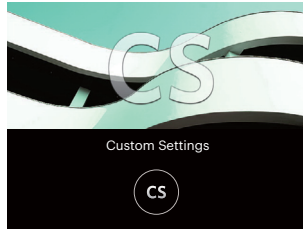
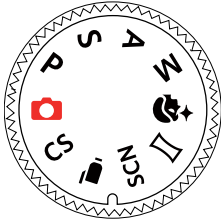

Auto Mode

Auto Mode is the most common and easiest mode to take photos. While operating in this mode, the camera automatically optimizes numerous camera settings to optimally adjust settings for your photos and videos for the best possible results.

Program AE **P**

The user can switch the ISO and EV value according to personal preference, the camera can automatically set the shutter speed and aperture value.

Shutter Priority **S**

This setting allows you to adjust the shutter speed, EV value and ISO value. The camera automatically sets the aperture value based on the shutter speed and ISO value to get the most appropriate exposure value.

Aperture Priority **A**



In this mode, you can adjusting the aperture size, EV and ISO values. The large aperture is to highlight the object focused through blurring the background, while the small aperture is for clear focusing on both the background and the object.

Manual Mode **M**



The user can adjust the aperture, shutter speed and ISO values manually. This setting is generally used to shoot static photos.

Face Beautifier

This mode automatically enhances facial features with skin softening touches and eye brightening capabilities.

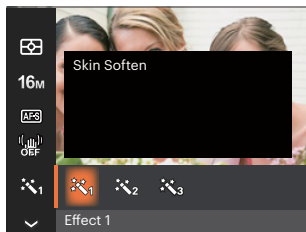







1. Press the  button and press the [▲ AF] / [▼ 🗑️ ⏻] button to select .
2. Press the [🌿] / [⚡] button to select an option and press the  button to confirm and enter the shooting screen.









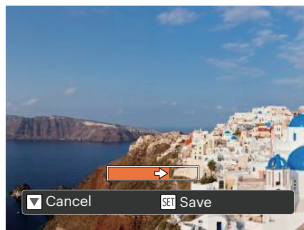

-  Effect 1
Skin Soften
-  Effect 2
Skin Soften + Eye Brightening
-  Effect 3
Skin Soften + Eye Brightening + Eye Enlargement

Panorama Mode

This feature allows you to capture a panoramic view that will have significantly more content than a single photograph. Follow the instruction arrow with a smooth and steady movement of the camera to seamlessly shoot an ultra-wide scene of up to 360 degrees.

1. Press the [ AF] / [  ] / [ ] / [] button to select a shooting direction. (The right direction is used as default if you do not make any choice), 2 seconds later, the camera is ready to take pictures. You can also press the  button or half press the Shutter Button to be ready to take pictures.
2. Compose your shot on the LCD and press the Shutter Button half way down to focus on the subject. After focusing, continue to press the Shutter Button all the way down to take the first picture. At this time, the process dialog of panorama mode stitching appears on the screen.
3. Rotate the camera according to the set direction. When the range of rotation does not exceed the range that the camera can detect, the progress dialog along the indication arrow partially turns orange. When it completely turns orange, panorama mode shooting is finished.



-  In Panorama Mode, the Flash, Self-Timer, Macro Modes and Exposure Compensation are not available. Focus Adjustment is also not available at this time.
-  During Panorama Mode shooting, when the moving direction of the camera is wrong or the angle deviates from the internal settings, the LCD shows a warning message [Improper alignment. Please try again.] and the current pictures taken are saved.
-  During Panorama Mode shooting, press the  button to interrupt shooting and save the current pictures. Press the [  ] button to cancel shooting and delete previously taken pictures.
-  Panoramic images can be played back by the method of flash playing. Refer to the “Animation Panorama Playback” section on page 50.

Scene Mode SCN

You can press the [◀👉] / [▶⚡] button to select your desired scene from the 13 preset modes according to the type of environment you are shooting in, and press the (SET) button to confirm your selection. The camera then automatically configures the most appropriate settings for the best possible photos.

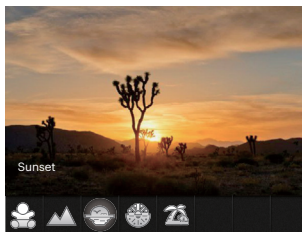
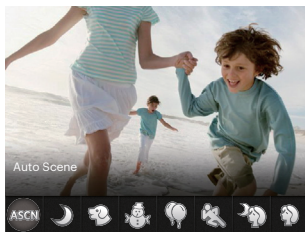







If in need of changing the scene, please press the (E) button and then the (SET) button and finally the [◀👉] / [▶⚡] button to reselect the scene.

Auto Scene ASCN

The camera can intelligently detect different environments and automatically select the best scene and photo settings for you.

ASCN can intelligently detect the following scenes:

-  Auto Mode The camera automatically adjusts the exposure and focus to ensure the best possible pictures.
-  Landscape Mode For landscapes, automatically adjusts the exposure and reproduces vivid green and blue colors.

-
- | | |
|--|---|
|  Backlit Portrait | When the sun or any other light source is behind the target you want to shoot, this mode automatically adjusts the foreground exposure to produce the best pictures possible. |
|  Macro Mode | The macro setting is ideal for shooting small objects or extreme close-up photos. |
|  Night Landscape Mode | For night scenes, this mode automatically increases the ISO value to compensate for low light. |
|  Portrait Mode | Most suitable for capturing people with focus on their faces. |
|  Night Portrait | When you take portraits at night, or in low light conditions, this mode automatically adjusts the exposure for people and night scenes. |

Night Landscape

For night scenes. Use of a tripod or a flat surface to rest the camera on is recommended with this setting.

Pet Mode

The camera automatically takes a picture when a dog or cat face is detected.

Snow

For snowy conditions. Reproduces natural, clear, white scenes.

Party

Suitable for taking indoor party pictures, even under complicated lighting conditions.

Sport

For fast-moving subjects. Captures sharp, action shots with minimal blur. This mode is not recommended for shooting indoors.

Night Portrait

For portraits against night scenery. Use of a tripod or a flat surface to rest the camera on is recommended with this setting.

Portrait

The camera is set to automatically adjust exposure for realistic capture of skin tones.

Children

Turns flash off automatically. Avoids disturbing the subject and is suitable for taking photos of children.

Landscape

For landscapes and outdoor shots. Vivid reproduction of greens and blues.

Sunset

For sunsets. Captures subjects in strong sunlight. Use of a tripod or a flat surface to rest the camera on is recommended with this setting.

Fireworks

For fireworks at night. Use of a tripod or a flat surface to rest the camera on is recommended with this setting.

Beach

For taking pictures in areas with strong sunlight.

Movie Mode



Switch to this mode to record videos.

1. Press down the Shutter Button to start recording.
2. Once you are finished, press the Fast Video Recording Button  or the Shutter Button to stop recording and return to the shooting screen.

Custom Settings CS



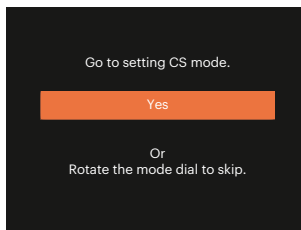
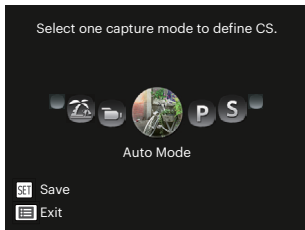

The user can store the frequently used shooting modes and parameters and switch to this mode for quick adjustment.

• Settings under CS mode (unset state or state after reset):

1. Turn the mode dial to select the mode **CS**, and enter the setup screen.
2. Press the [] / [] button to select a capture mode that you want to define as **CS**, and press the  button to enter the shooting screen.



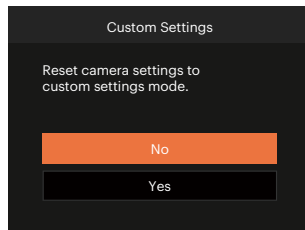
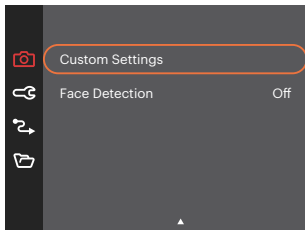

• **For setting under other modes (use this method to select a different custom setting):**

1. Select any mode to be stored and set your desired parameters in the current mode.
2. Press the  button, press the [▲ AF] / [▼ 🗑️ ⏸] buttons to select  and press the  button to enter the menu. Press the [▼ 🗑️ ⏸] button to select [Custom Settings] and press the  / [▶ ⚡] button to enter the menu afterwards.



3. Select [Yes] to save or [No] to cancel.
4. Turn the mode dial to switch to the custom settings (**CS**).
5. The photo settings you stored the last time are invoked.

 When the **CS** mode is used for the first time, there is no preset parameter stored in the **CS** mode.

 If you want to remove the parameter setting of [Custom Settings], please see the reset function on page 79 to operate.

BASIC OPERATION

Using the Zoom Function

Your camera is equipped with two types of zoom functions: Optical Zoom and Digital Zoom. Toggle the Zoom Lever of the camera to zoom in or out of the subject while taking pictures.

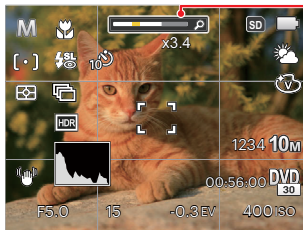
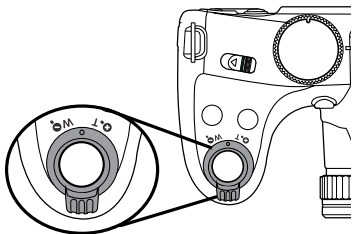

Zoom Indicator

When the Optical Zoom reaches the threshold as Digital Zoom, release and turn the Zoom Lever to T to switch between the Optical Zoom and Digital Zoom.

Focus Setting

This setting allows you to select different modes for optimum focus.

1. Press the [▲ AF] button to enter the Focus Menu.



2. Press the [◀🌸] / [▶⚡] buttons to select the following 3 modes:
 - [◦] Single-AF
The focus frame appears on the center of the LCD to help you focus on the subject.
 - [∞] Multi-AF
The camera automatically focuses the subject in a wider area to find the focal point.
 - [🔄] Object Tracking
Smart tracking of the object in motion under the focusing shooting.
3. Press the [SET] button to confirm the settings and exit the menu.





 When  is enabled, Object Tracking function is not available.

Macro Mode

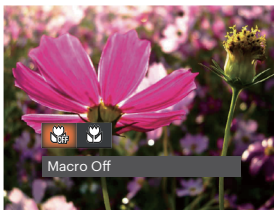
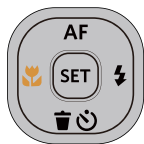
The Macro Setting is ideal for shooting small objects or close-up photos. This mode allows you to focus on subjects very close to the camera and will provide very detailed photos.

1. Press the [] button to enter the Macro Menu.





2. Press the [] / [] buttons to select the following 2 modes:
 -  Macro Off
Select this option to disable Macro.
 -  Macro On
Select this option to focus on subjects 3cm from the lens.
3. Press the  button to confirm the settings and exit the menu.



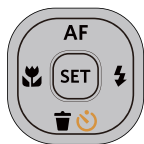

Self-Timer Setting

Use this function to take pictures at pre-set intervals. The camera shutter speed can be set to 2 seconds, 10 seconds or Smile Detection.

1. Press the [] button to enter the Self-Timer Menu.



2. Press the [] / [] buttons to select one of the following 4 modes:

-  Self-Timer Off
Disables the Self-Timer.
-  Self-Timer 2sec
A single picture is shot 2 seconds after the Shutter Button is pressed.
-  Self-Timer 10sec
A single picture is shot 10 seconds after the Shutter Button is pressed.
-  Self-Timer Smile
Press the Shutter Button and a picture will be taken immediately after a smile is detected.

3. Press the  button to confirm the settings and exit the menu.

When enabling the Self-Timer feature, pressing the Shutter Button or the [▼🗑️🕒] button can disable the Self-Timer and return to the shooting screen without keeping the Self-Timer setting.

When enabling Smile Detection, pressing the Shutter Button or the [SET] button can disable the Self-Timer and return to the shooting screen without keeping the Self-Timer Smile Setting.

Flash Mode



The flash provides supplemental light for scenes. The flash is usually used when shooting against the light to highlight the object; it is also suitable for metering and shooting in darker scenes to improve the exposure.

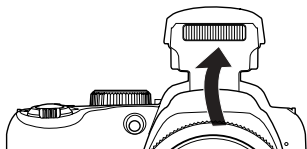



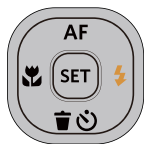

1. Pop the flash up manually as shown below:



2. Press the [▶⚡] button to enter the Flash Settings Menu.



3. Press the [] / [] buttons to select one of the following 6 modes:

-  Force Off
Flash is turned off.
-  Flash Auto
Camera flash goes off automatically based on lighting conditions.
-  Force Flash
The flash will engage with each shot even if there is enough available light to take the photo without flash.
-  Slow Sync.
This allows you to take pictures of people at night that clearly show both your subjects and the night time backdrop. The use of a tripod is recommended when shooting with this setting.
-  Slow Sync. + Red-Eye
Use this mode for slow synchrony shots with red-eye reduction.
-  Red-Eye Reduction
The camera emits a brief pre-flash before the picture is taken to reduce red-eye effects.



4. Press the  button to confirm the settings and exit this option.











White Balance Setting

The White Balance setting allows you to adjust the color temperature for different lighting scenes to ensure the most accurate color reproduction.

1. Press the  button to enter the White Balance Settings Menu.



2. Press the [] / [] buttons to select one of the following 8 modes:

-  AWB
-  Daylight
-  Cloudy
-  Fluorescent
-  Fluorescent CWF
-  Incandescent
-  Manual WB
(Fully press the Shutter Button to detect the White Balance value)
-  Color Temp. (1900K-10000K)
Press the [ AF] / [] buttons to “Adjust the K value”; Press the [] button to exit the K value.



3. Press the  button to confirm the settings and exit this option.

Continuous Shot

Use this setting to perform Continuous Shooting. After entering this mode, you can shoot multiple images by continuously holding the Shutter Button down.

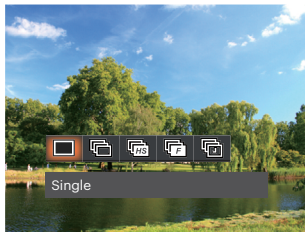
1. Press the  button to enter the Continuous Shot Settings Menu.



2. Press the [] / [] buttons to select one of the following 5 modes:

-  Single
-  Continuous Shot
-  Cont.Shot - High Speed (VGA)
-  Cont.Shot - Fast (2M)
-  Time - Lapse (30sec/1min/5min/10min)

3. Press the  button to confirm the settings and exit this option.

4. Press the Shutter Button to start shooting.



The flash is disabled in Continuous Shot Mode in order to achieve quick succession of shots.

EV Setting

The EV Function Menu of the camera includes functions, such as EV, ISO, Shutter and Aperture Adjustment. Using the appropriate Function Settings can improve your pictures.

1. Press the **(M)** button to display the Settings screen.
2. Press the [**◀** **⬇**] / [**▶** **⚡**] buttons to select the Setting options.

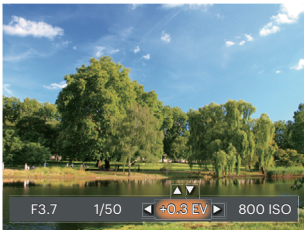

3. Press the [**▲** **AF**] / [**▼** **☑**] buttons to adjust the option values.
4. Press the **(SET)** button to complete the setting and enter Shooting Mode.

Exposure Compensation

Set up Exposure Compensation to adjust the picture brightness. If there is very high contrast between the photographed object and the background, the brightness of the picture can be adjusted as necessary.

The adjustable range of exposure value is from EV -3.0 to EV +3.0.

ISO

The ISO Function allows you to set the sensitivity of the camera's light sensor based on the brightness of the scene. To improve the camera's sensor performance in darker environments, a higher ISO value is required. A lower ISO value is needed when shooting in brighter conditions.

Pictures taken at higher ISO settings will generally have more noise than those taken at lower ISO settings. The camera's ISO settings include: Auto, 100, 200, 400, 800, 1600 and 3200.

Shutter Adjustment

For shutter speed, the camera may automatically set the aperture value corresponding to the manually set shutter speed to obtain the most suitable exposure value. The movement of objects may be shown by adjusting the shutter speed. High shutter value can help you more clearly capture fast moving objects, while low shutter value can better show the movement of objects.

Aperture Adjustment

You can adjust the aperture size value. Selecting a large aperture opening will emphasize the point of focus and show a blurry background and foreground. A small aperture opening will keep both the background and main object in clear focus.

Using Quick Recording

In the Photo Shooting Mode, press the Fast Video Recording Button  to begin recording video.

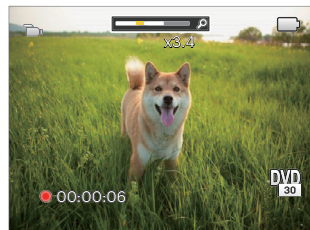

Once you are finished, press the Fast Video Recording Button  or the Shutter Button to stop and store the video. The camera will return to the Shooting Mode automatically.

Color Setting

The image color setting allows you to select different color effects.

1. Press the **(i)** button to enter the Color Effect Settings Menu.
2. Press the [**◀** **📷**] / [**▶** **⚡**] buttons to select the color effect setting options.

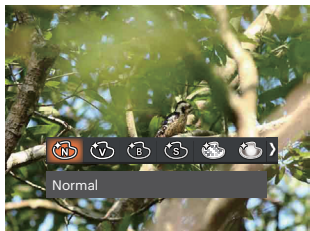

There are 7 options in **P S A M** Mode:

- **(N)** Normal
- **(V)** Vivid
- **(B)** Black and White
- **(S)** Sepia
- **(D)** Dreamy
- **(V)** Vignetting
- **(S)** Salon

There are 4 options in Movie Mode (**📹**):

- **(N)** Normal
- **(V)** Vivid
- **(B)** Black and White
- **(S)** Sepia

(📄) When the mode other than **P S A M** **📹**, is set to **CS** mode, the color effect cannot be adjusted.

(📄) When HDR or Continuous Shot function is enabled, Dreamy, Vignetting and Salon cannot be displayed.

Options in the Shooting Mode (O: Available X: Unavailable)





If each option is available in the mode set to **CS**, the option is available in **CS** mode; otherwise, it is not available.

Options	Shooting Modes								
		P	S	A	M			SCN	
[•]	O	O	O	O	O	X	X	X	X
	O	O	O	O	O	O	X	O ()	O
	O	O	O	O	O	O	X	O (Except)	O
	O	O	O	O	O	O	X	O ()	X
AUTO WB	X	O	O	O	O	X	X	X	X
	O	O	O	O	O	X	X	O ()	X
EV	X	O	O	O	X	O	X	X	O
ISO	X	O	O	O	O	O	X	X	X
Shutter	X	X	O	X	O	X	X	X	X
Aperture	X	X	X	O	O	X	X	X	X
	X	O	O	O	O	X	X	X	O

PLAYBACK

Viewing Photos and Videos

To view captured photos and video clips on the LCD:

1. After pressing the  button, the last photo or video clip taken will be displayed on the LCD.
2. Use the [] / [] buttons to scroll through the photos or video clips stored on the built-in memory or on the Memory Card in the camera.
3. To play a selected video clip, press the  button to enter the Movie Playback Mode.

An operation guide appears on the screen when playing back a video. Press the appropriate buttons to enable the corresponding functions.

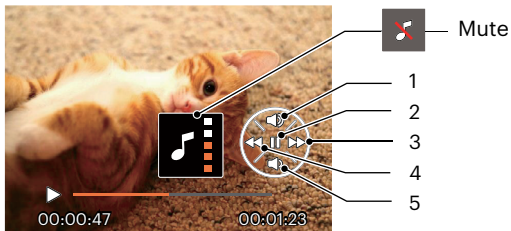

1	Increase Volume
2	Pause
3	Fast Forward
4	Rewind
5	Decrease Volume

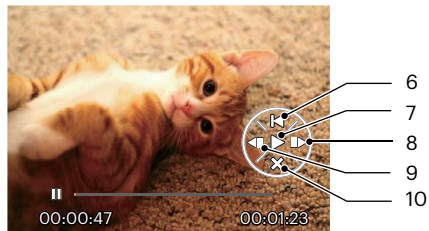







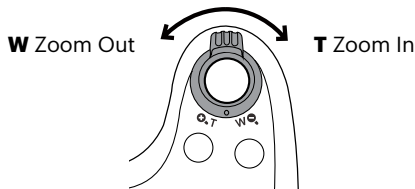

6	Return Back to the Beginning of the Video
7	Play
8	Frame Forward
9	Frame Backward
10	Cancel Playback

Thumbnail View

When in Playback Mode, rotate the Zoom Lever counter clockwise to the position **W**  to display thumbnail images of the photos and videos on the LCD screen.



• For Normal Mode

1. Slide the Zoom Lever to switch between 3 x 3 and 4 x 4 thumbnails.
2. When a 3 x 3 or 4 x 4 thumbnail is displayed, press the [ **AF**] / [  ] / [ ] / [ ] buttons to select the picture or video clip to view. Press the  button to restore it to the original size.

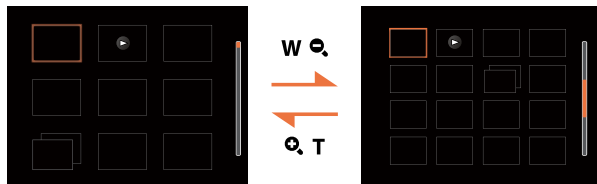

• **For Date Mode or Cont.Photo Mode**

1. Press the button to display the playback screen and press the button to enter the menu.
2. Select and press the button to confirm.
3. Press the [] / [] buttons to select / .
4. Slide the Zoom Lever to switch between 2 x 2 and 4 x 4 thumbnails.
5. When a 2 x 2 or 4 x 4 thumbnail is displayed, press the [AF] / [] / [] / [] buttons to select the picture or video clip to view. Press the button to restore it to the original size.

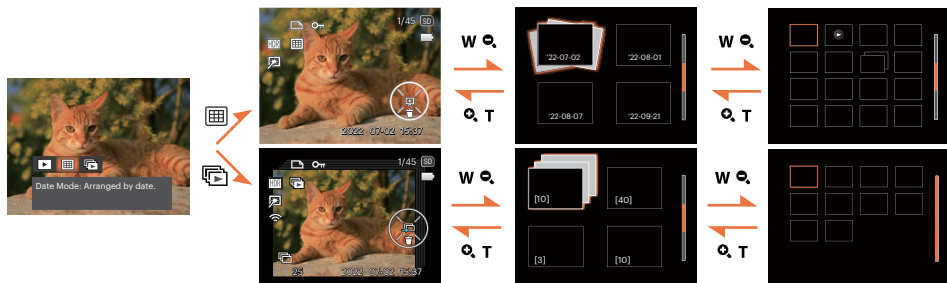

If the indicator appears on the LCD, then a movie file is currently being displayed.

Press the button to restore a preview icon to its original image size.

Using Zoom Playback (for still pictures only)

When playing back photos, you can also use the Zoom Lever to zoom in on the photos, 2 to 8 times their original magnification.

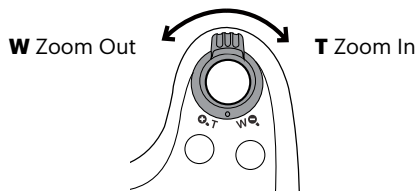

1. Press the [◀📷] / [▶📷] buttons to select the picture on which to use the zoom feature.
2. Rotate the Zoom Lever to **Q, T** to zoom in.
3. The bottom right corner of the screen will display the amount zoomed in as well as the area of the photo shown.

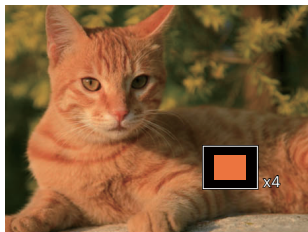

4. Press the arrow buttons to navigate and select the desired portion of the photo to be zoomed in on.
5. Press the **SET** button to return the image to its original scale.







Movie images cannot be magnified.





Please note: This camera's LCD is only capable of displaying a fraction of the detail and resolution of the actual photo or video file. Once photos / videos are downloaded to your computer, you will see the full resolution of the photo / video file captured.

Slideshow

This setting allows you to view all the stored pictures as a slideshow.

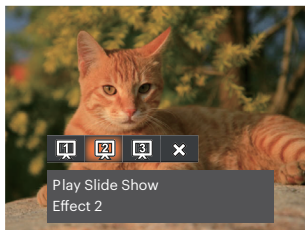



1. Press the  button to enter playback screen.
2. Press the  button to enter slide option.
3. Press the [] / [] buttons to select slideshow playing or [Cancel] to return to the playback screen.



- Play Slide Show Effect 1 Fade in and out
 - Play Slide Show Effect 2 Left and right interlaced
 - Play Slide Show Effect 3 Animated photo tile effect
4. Press the  button to confirm the setting.

Animation Panorama Playback

The panoramic animation will be played back as a full-size image in accordance with the shooting direction.

1. Press the  button to enter playback screen.
2. Press the [] / [] button to select the animated panoramic photos.
3. Press the  buttons to playback in selected shooting direction.

Animation panorama

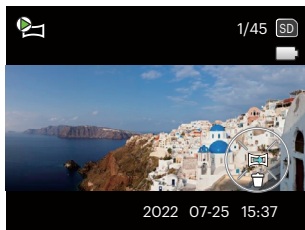



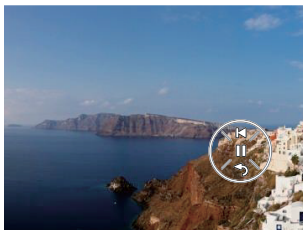

Playing



Pause



4. During playback, press the  button to pause playback, and then press the  button to resume playback. Press the [] button to select , it will stop playback and return to the static image of the panoramic image.
5. After playback, it will automatically return to the static image of the panoramic image.



Rotation is not performed during animation panorama playback or pause.

Photos and Video Deletion

In Playback Mode, press the [▼🗑️🕒] button to select your desired photos and videos.

To delete photos or videos:

1. Press the [⏮] button to switch to Playback Mode.
2. Press the [◀️🗑️] / [▶️🗑️] buttons to select the photos and videos to be deleted.
3. Press the [▼🗑️🕒] button and the deletion screen is displayed.

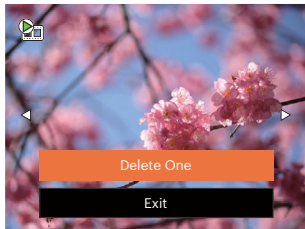

4. Press the [▲AF] / [▼🗑️🕒] buttons to select [Delete One] or [Exit] and press the [SET] button to confirm.



Erased photos / video clips cannot be recovered.











Please refer to 70 for instructions on deleting more than one image at a time.

USING THE MENUS

Photo Menu

Mode:  **P** **S** **A** **M**   **SCN** **CS**

1. In Photo Shooting Mode, press the  button to enter the Photo Shooting Menu.
2. Press the [ **AF**] / [ ] buttons to select the Photo Shooting Menu and settings.
3. Press the [ ] / [ ] buttons to select the Photo Shooting Menu to be set and press the  button to confirm.

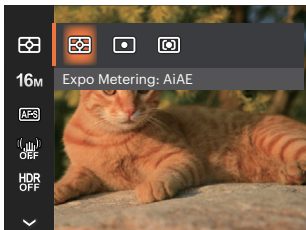

Expo Metering (Exposure Metering)

Use this setting to select the “target” size of the camera’s field of view to be metered.

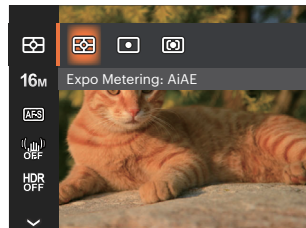

- **AiAE (Artificial Intelligence AE)** Automatically selects the central and peripheral metering, to calculate the reasonable value of metering by weighting.
- **Spot** Metering targets a small area in the center of the camera’s field of view.
- **Center** Metering targets a slightly larger area in the center of the camera’s field of view.

Image Size 16M

The Size Setting refers to the image resolution in pixels. A higher image resolution allows you to print that image in larger sizes without degrading the photo image quality.

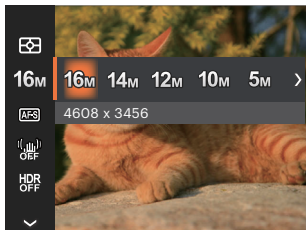

- 16M: 4608 x 3456
- 14M: 4608 x 3072 (3:2)
- 12M: 4608 x 2592 (16:9)
- 10M: 3648 x 2736
- 5M: 2592 x 1944
- 3M: 2048 x 1536
- 2M: 1920 x 1080 (16:9)
- VGA: 640 x 480



The bigger the number of recorded pixels is, the better the image quality becomes. As the number of recorded pixels lessens, you will be able to record more images on a memory card.

Continuous AF **AFS**

Use the Continuous AF setting to be able to continuously focus automatically when taking pictures.

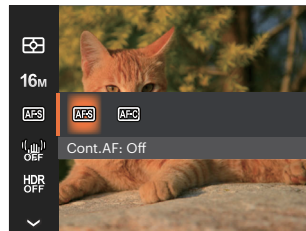



- Cont.AF: Off
- Cont.AF: On

OIS (Optical Image Stabilization)

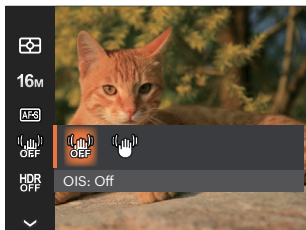
This mode can help reduce photo blur caused by unintentional hand shake, or low light.



- OIS: Off
- OIS: On

-  Use this Image Stabilization Mode in dark environments.
-  Shooting in a windy or unstable environment (such as a moving vehicle) may cause blurred images.
-  When using a tripod, we suggest that the image stabilization setting be turned “Off”.

HDR (High Dynamic Range)



Use this setting to control wide dynamic image range when taking static pictures. Photos with extreme contrast of bright and dark areas will still maintain distinguishable detail and depth. (Suggest using tripod)

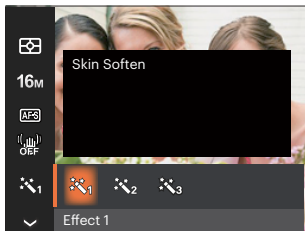

- HDR: Off
 - HDR: On
-  When shooting in a high light contrast situation, we suggest using the HDR setting to compensate and provide the best photos possible.

Face Beautifier





-  Effect 1
Skin Soften
-  Effect 2
Skin Soften + Eye Brightening
-  Effect 3
Skin Soften + Eye Brightening +
Eye Enlargement

Scene

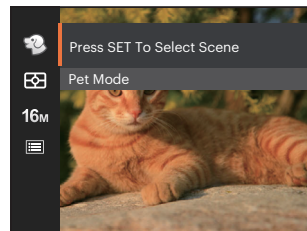
Select a scene under Scene Mode (**SCN**). Refer to the “Scene Mode” section on page 28.



In  mode, you can press the [] button on the shooting screen to set up Auto shooting.

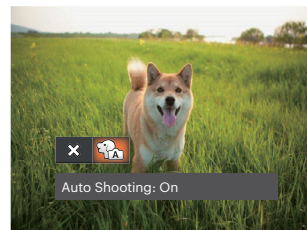
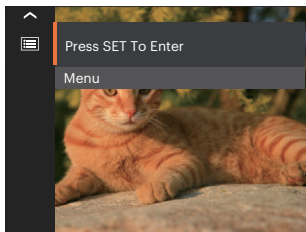

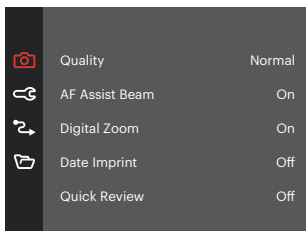

Photo Shoot Settings Menu



Press the  button to enter the menu.



Quality

The Quality Setting can be used to adjust the image compression ratio.



- Best 16M Average File Size: 4.0MB
- Fine 16M Average File Size: 2.3MB
- Normal 16M Average File Size: 2.0MB

AF Assist Beam

In a darker environment, the AF assist beam setting can be turned on for better focus.

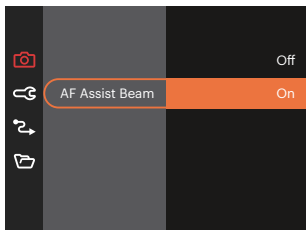

Digital Zoom

This setting is for adjusting digital zoom. If this function is disabled, only optical zoom can be used.

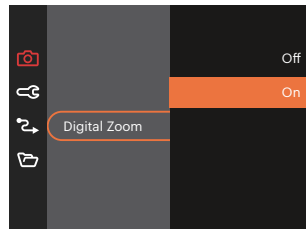

Date Imprint

Include a Date/Time stamp on the photo image.

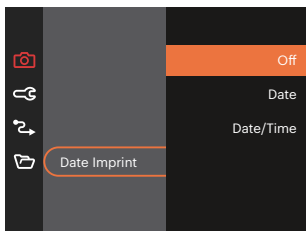

Quick Review

This option allows quick review of the photos immediately after they are taken. Each photo is displayed on the LCD screen based on the selected time.

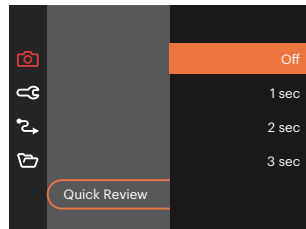

Custom Settings

Custom Settings stores the current Photo Shooting Mode and its parameters. The stored mode and parameters are directly invoked in Custom Settings Mode.

- Select [Custom Settings] under other modes

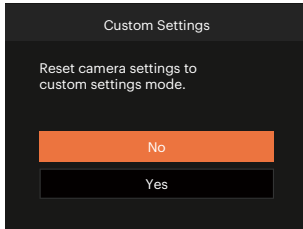

- Select [Custom Settings] under **CS** mode

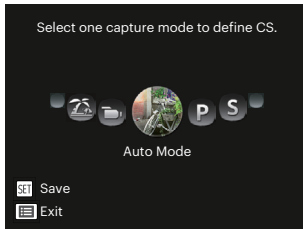

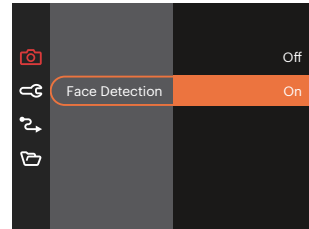

Face Detection

Detects and focuses on faces to make all faces as clear as possible in Photo Mode.









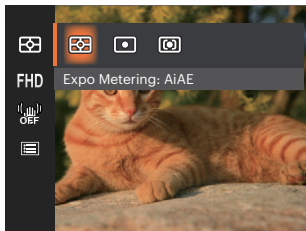

Movie Menu

Mode: 

1. Turn the Mode Dial to select the  mode and press the  button to enter the Movie Menu.



2. Press the [ ▲ AF] / [ ▼  ] buttons to select the Movie Menu to be set.
3. Press the [ ◀ ] / [ ▶ ] buttons to select the Movie Menu to be set and press the  button to confirm.

Expo Metering (Exposure Metering)

Use this setting to select the “target” size of the camera’s field of view to be metered.

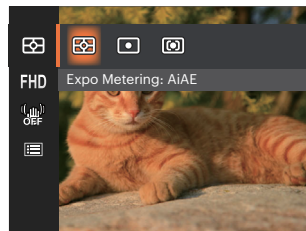

- AiAE (Artificial Intelligence AE) Automatically selects the central and peripheral metering, to calculate the reasonable value of metering by weighting.
- Spot Metering targets a small area in the center of the camera’s field of view.
- Center Metering targets a slightly larger area in the center of the camera’s field of view.

Video Quality FHD

Set the image resolution used during video recording.

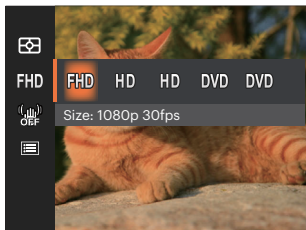

The speed requirements for reading and writing high resolution image pixel images to an SD card are as follows:

No.	Image Pixels	Frames	Recording Time (32GB) About
1	1920 x 1080 *	30	65 Minutes
2	1280 x 720 *	60	68 Minutes
3	1280 x 720 *	30	136 Minutes
4	640 x 480	30	276 Minutes
5	640 x 480	120	70 Minutes

 * The longest recording time is 29 minutes at one time.

 If the recorded video segment/file exceeds 4GB:

- 1) The camera will automatically generate a new separate file(s) sequentially and will continue recording until the SD memory card is full.
- 2) Each sequential recorded file of 4GB (max) will be a separate file and cannot be played back continuously.
To playback files, please manually select each one to view.

 When recording in higher pixel resolutions for extended periods of time, this can cause the camera to generate heat. This is not a camera malfunction.

 Sound recording is disabled when 640 x 480 (120fps) is chosen.



 When the video format is set as 640 x 480 (120fps), the shooting time is 30 seconds and the playback time is 2 minutes.

OIS (Optical Image Stabilization)

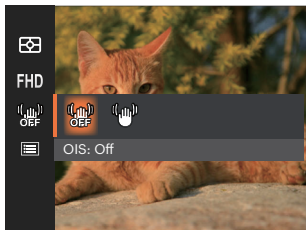
This mode can help reduce video images blur caused by unintentional hand shake, or low light.



- OIS: Off
- OIS: On

-  Use this Image Stabilization Mode in dark environments.
-  Shooting in a windy or unstable environment (such as a moving vehicle) may cause blurred images.
-  When using a tripod, we suggest that the image stabilization setting be turned “Off”.

Movie Shooting Settings Menu

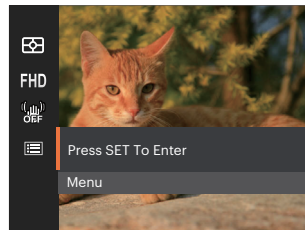

Press the  button to enter the menu.

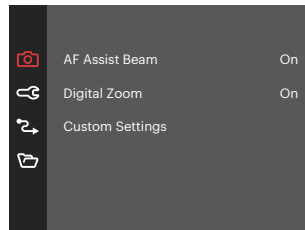

AF Assist Beam

In a darker environment, the AF assist beam setting can be turned on for better focus.

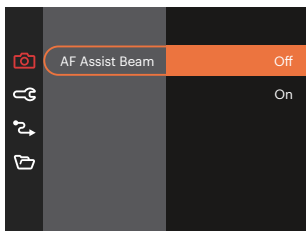

Custom Settings

Custom Settings stores the current Photo Shooting Mode and its parameters. The stored mode and parameters are directly invoked in Custom Settings Mode.

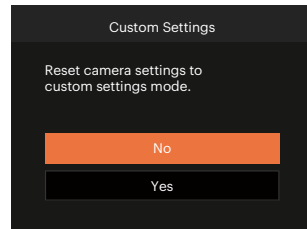





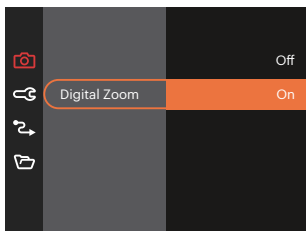







Digital Zoom

This setting is for adjusting Digital Zoom. If this function is disabled, only Optical Zoom can be used.





Options in the Shooting Mode (O: Available X: Unavailable)

If each option is available in the mode set to **CS**, the option is available in **CS** mode; otherwise, it is not available.



Options	Shooting Modes										
		P	S	A	M			SCN			
											
	O	O	O	O	O	O	X	O	O	O	O
16M	O	O	O	O	O	O	X	O	O	O	X
FHD	X	X	X	X	X	X	X	X	X	X	O
	O	O	O	O	O	O	X	X	O	X	X
	O	O	O	O	O	O	X	X	X	X	O
	X	X	X	X	X	O	X	X	X	X	X
	O	O	O	O	O	X	X	O	O	X	X
	O	O	O	O	O	O	O	O	O	O	O

Playback Menu

Mode: 

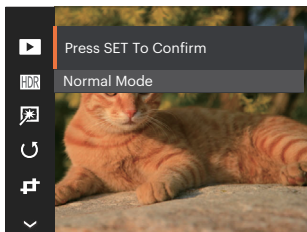



1. Press the  button to display the playback screen and press the  button to enter the menu.

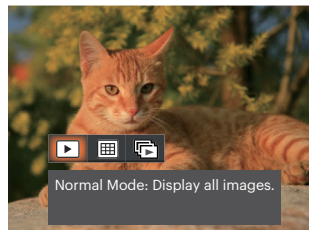

2. Press the [▲ AF] / [▼ ⏏ ⏻] buttons to select the playback desired and press the  button to enter.
3. Press the [▲ AF] / [▼ ⏏ ⏻] or [◀ ⏏] / [▶ ⚡] buttons to select an option and press the  button to confirm.

Display Mode





-  Normal Mode: Display all images.
 -  Date Mode: Arranged by date.
 -  Cont.Photo Mode: Arranged by Cont.Photo Group.
-  The Date Folder is displayed in date order based on photo shooting date/time.
-  If there is no continuous shot image file in memory, Cont.Photo Mode cannot be enabled.

HDR (High Dynamic Range)

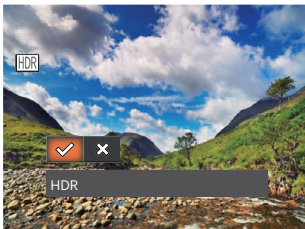
With the HDR function, pictures that are overexposed may be corrected to optimize the highlights and lowlights captured to more accurately represent the actual scene.







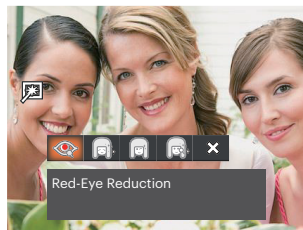

-  HDR
-  Cancel

 After using the HDR function, the image will be saved as a new file and the original file is still stored on the memory card.

Touch-up

The playback beauty feature allows for beautification using three individual effects.





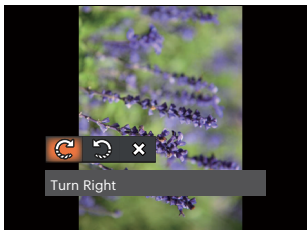

-  Red-Eye Reduction
-  Skin Soften
-  Eye Brightening
-  Eye Enlargement
-  Cancel

Rotate

You can use this setting to change the orientation of the picture.



-  Turn Right
-  Turn Left
-  Cancel



 Videos and panoramic pictures cannot be rotated.

 The rotated picture file will replace the original photo.

Resize

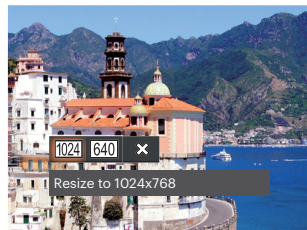
This setting allows you to resize a picture to a particular resolution and saves it as a new picture.





-  Resize to 1024 x 768
-  Resize to 640 x 480
-  Cancel

 Only for adjusting pictures with high resolution to those with a lower resolution.

 Sizes of photos taken in panorama mode or rotated cannot be adjusted.

Color

This setting allows you to change the picture color effect. The file is saved as a new photo and stored in memory together with the original photo.

1. Press the **(i)** button to enter the Color Effect Settings Menu.
2. Press the [] / [] buttons to select the color effect setting options.

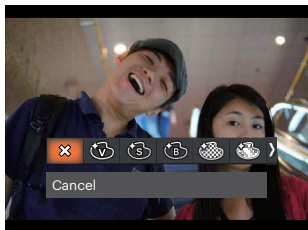

-  Cancel
-  Vivid
-  Sepia
-  Black and White
-  Grainy
-  Dreamy
-  Vignetting
-  Salon

Playback Settings Menu

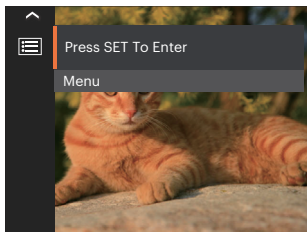

Press the  button to enter the menu.

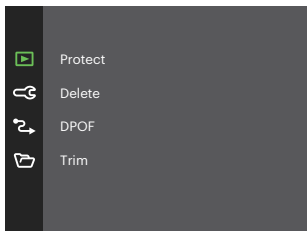

Protect

To prevent any pictures or videos from being accidentally erased, use this setting to lock one or all of the files stored on the memory card.

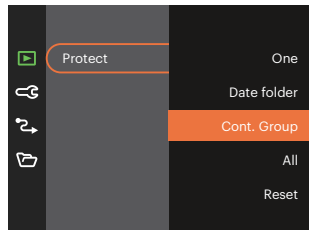

- **One** Lock the selected photo or video if they are unprotected; unlock the selected photo or video if they are protected.
- **Date Folder** Protect all photos in the Date Folder.
- **Cont. Group** Protect all photos in the Cont. Group.
- **All** Lock all photos or videos.
- **Reset** Cancel all locked photos or videos.

Delete

You can delete one or all photo/video files.

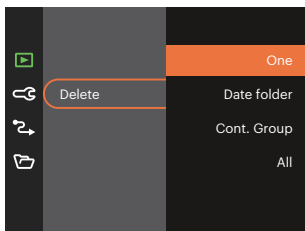

- One Delete one photo or video.
- Date Folder Delete all photos in the Date Folder.
- Cont. Group Delete all photos in the Cont. Group.
- All Delete all photos or videos.

 The “🔒” indicator means a file is protected. File protection must be removed before a file can be deleted.

 Deleting files will cause DPOF settings to be reset.

 Deleted files will be permanently deleted and will not be able to be recovered or restored.

DPOF (Digital Print Order Format)

The DPOF feature allows you to compile and select a group of pictures that you would like to print and will save your selection on the memory card so that you can use the memory card to print without having to individually specify the photos you want to print.

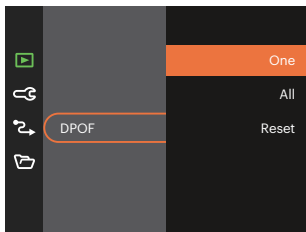





 A printer that supports DPOF is needed for photo printing.

Trim

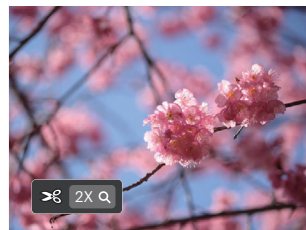
The Trim setting allows you to crop photos and save them as new pictures.















1. Select [Yes] to confirm trim. Select a section of the photo to be trimmed using the Zoom Lever and the [▲ AF]/[▼ 0]/[◀]/[▶] buttons to trim a photo.











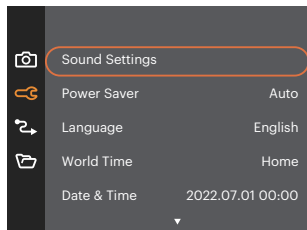







2. Press the **(SET)** button and the [Save change?] prompt appears. Select [✓] to change and save the picture. Select [✕] to cancel changes and return to the trim prompt screen.
-  The image cannot be clipped/trimmed again once it has been clipped to 640 x 480.
 -  Videos cannot be trimmed in camera.
 -  The picture after trimming cannot be trimmed again.

General Settings

Mode:  **P** **S** **A** **M**   SCN  CS 

1. Press the  button and press the [ AF] / [  ] buttons to select . Press the  button to enter the menu.
2. Press the [ AF] / [  ] buttons to select  and press the  / [ ] button to enter the menu.



3. Press the [ AF] / [  ] buttons to select the item to be set and press the  / [ ] button to enter the menu.
4. Press the [ AF] / [  ] or [ ] / [ ] buttons to select an option, and press the  button to confirm.

Sound Settings

With this setting you may adjust the sound volume.

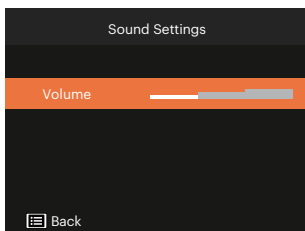

Power Saver

This setting allows you to save power and get the maximum possible running time for your camera's batteries.

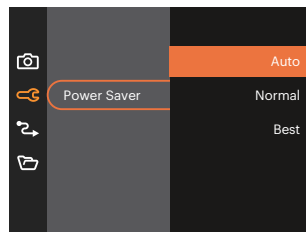

Power Saver	LCD power off time	Turn off time
Auto	3 min	5 min
Normal	1 min	3 min
Best	30 s	1 min

Language

Refer to the “Resetting your Language” section on page 19.

World Time

The Zone setting is a useful function for your overseas trips. This feature enables you to display the local time on the LCD while you are abroad.

1. Press the [▲ AF] / [▼ ⓧ ⓧ] buttons to select the departure place (🏠) and destination (🌐) fields.
2. Press the [◀ ⓧ] / [▶ ⚡] buttons to select a city located in the same time zone as that of the field. Press the (SET) button to confirm settings.

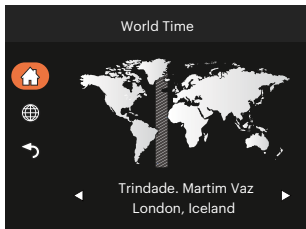

Date & Time

Refer to the “Resetting Date/Time” section on page 20.

LCD Brightness



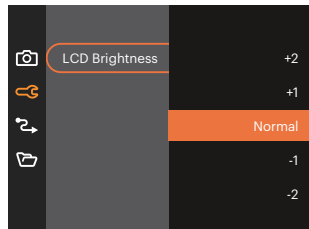



Use this setting to adjust the brightness of your LCD.



- ⓘ Setting and adjusting your camera's LCD brightness to the lowest setting will help conserve your camera's battery life and longevity. Using the LCD screen on the brightest setting will drain your batteries more quickly.

Connection Settings ↻

Mode:  **P** **S** **A** **M**   SCN  CS 

1. Press the  button and press the [▲ AF] / [▼ 𐀀 𐀁] buttons to select . Press the  button to enter the menu.
2. Press the [▲ AF] / [▼ 𐀀 𐀁] buttons to select  and press the  / [▶ ⚡] button to enter the menu.
3. Select [USB] and press the  / [▶ ⚡] button to enter the menu.

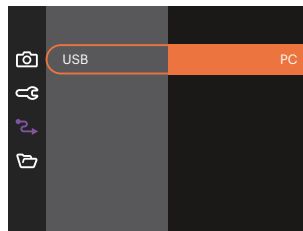
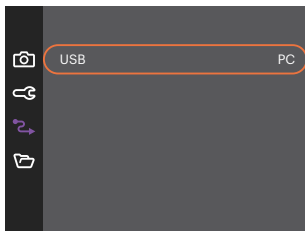

Connecting to a Computer

You can use a USB cable to connect the camera and copy (transmit) photos to a computer (PC or Mac) or other device.

Transferring Files to Your Computer

The computer will automatically detect the camera as a removable drive. Double-click the “My Computer” icon on the desktop to locate the removable drive and to copy folders and files in the drive to a directory on your computer as you would copy any typical folder or file.





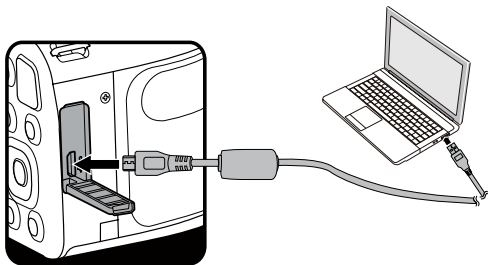









Follow the steps below to connect the camera to a computer:

1. Make sure both the camera and computer are turned on.
2. Connect one end of the supplied USB cable to the USB port on your camera.
3. Connect the other end of the cable to an available USB port on your computer
4. After the transmission is complete, disconnect the USB cable according to your computer manufacturer's instructions specifying how to safely remove USB devices.









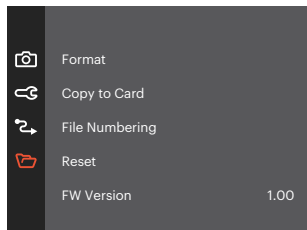





File Settings

Mode:  **P** **S** **A** **M**   SCN  CS 

1. Press the  button and press the [ **AF**] / [  ] buttons to select . Press the  button to enter the menu.
2. Press the [ **AF**] / [  ] buttons to select  and press the  / [ ] button to enter the menu.



3. Press the [ **AF**] / [  ] buttons to select the item to be set and press the  / [ ] button to enter the menu.
4. Press the [ **AF**] / [  ] button to select an option and press the  button to confirm.

Format

Please Note: formatting enables you to delete all contents on the memory card and camera's built-in memory, including protected photo and movie files.

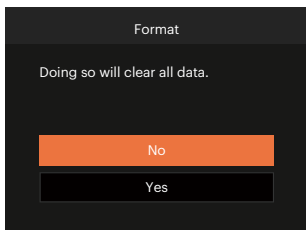

Copy to Card

Use this setting to copy the files stored in the camera's built-in memory to a memory card.

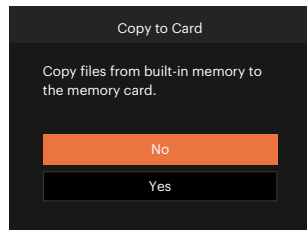

If there is no memory card in the camera, the built-in memory will be formatted; if there is a memory card, only the memory card will be formatted.



If there is no card available in the camera, this function will not be displayed.

File Numbering

After you take a picture or video clip, the camera will automatically save it with a sequential number. You can use this to reset the file numbering to 1.

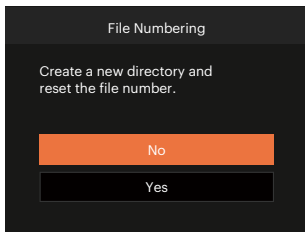

Reset

Use this setting to restore the camera to its original factory default settings.

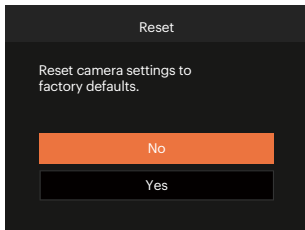

Firmware (FW) Version

Use this setting to view the current camera firmware version.

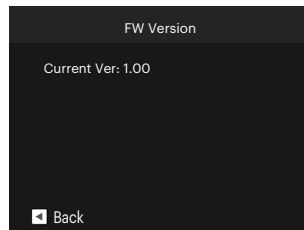

When there is a new firmware version in the SD card, select [Yes] to update.

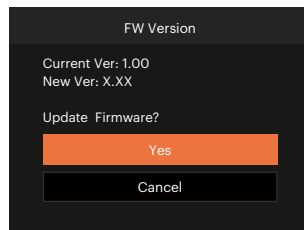

APPENDICES

Specifications



Design and specifications are subject to change without notice.

Image Sensor	Type	1 / 2.3"BSI CMOS
	Effective Pixels	16.35 Megapixels
	Total Pixels	16.76 Megapixels
Lens	Focal Length	4.3mm (Wide) – 107.5mm (Tele)
	35mm Film Equivalent	24mm (Wide) – 600mm (Tele)
	F Number	F3.7 (Wide) – F6.2 (Tele)
	Lens Construction	11 groups 12 elements
	Optical Zoom	25x
	Focusing Range	Normal: (Wide) 60cm ~ ∞ (Tele) 250cm ~ ∞ Macro: 3cm ~ ∞ (Wide Only)
Autofocus System	TTL Autofocus	
Anti-Handshake	Optical Image Stabilization	
Digital Zoom	4x Digital Zoom (Combined Zoom: 100x)	

Number of Recording Pixels	Still Image	(4:3) 16MP: 4608 × 3456 10MP: 3648 × 2736 5MP: 2592 × 1944 3MP: 2048 × 1536 0.3MP: 640 × 480	(3:2) 14MP: 4608 × 3072	(16:9) 12MP: 4608 × 2592 2MP: 1920 × 1080
	Movie	1920 × 1080 (30fps), 1280 × 720 (60fps), 1280 × 720 (30fps), 640 × 480 (30fps), High-Speed Movie: 640 × 480 (120fps)		
Image Compression		Best, Fine, Normal		
DCF, DPOF (Ver1.1) Support		Yes		
File Format	Still Image	Exif 2.3 (JPEG)		
	Movie	Movie Format: MOV (Motion JPEG), Audio: Linear PCM [Monaural]		
Shooting Modes		Auto Mode, Program AE, Shutter Priority, Aperture Priority, Manual Mode, Face Beautifier, Panorama Mode, Scene Mode, Movie Mode, Custom Settings		
Scene Mode		ASCN, Night Landscape, Pet Mode, Snow, Party, Sport, Night Portrait, Portrait, Children, Landscape, Sunset, Fireworks, Beach		
Detection Features		Face, Smile, Blink, Cat, Dog		
Photo Touch-up		Red-Eye Reduction, Skin Soften, Eye Brightening, Eye Enlargement		
HDR		Yes		

Scan Panorama	Up to 360°
LCD Display	3.0 inch (460k Pixels)
ISO Sensitivity	Auto, ISO 100 / 200 / 400 / 800 / 1600 / 3200
AF Method	Single AF, Multi-AF (TTL 9-point), Object Tracking, Face-Detection
Exposure Metering Method	Artificial Intelligence AE (AiAE), Center-Weighted Average, Spot (Fixed to Center of Frame), Face AE
Exposure Control Method	Program AE (AE-Lock Available), Shutter Prior AE, Aperture Prior AE
Exposure Compensation	±3EV in 1/3 Step Increments
Shutter Speed	1/2000 ~ 30 Seconds
Continuous Shooting	Yes
Playback Modes	Single Photo, Index (9/16 Thumbnails), Slide Show, Date Mode, Burst Shooting, Zoom (Approx. x2 ~ x8)
White Balance Control	AWB, Daylight, Cloudy, Fluorescent, Fluorescent CWF, Incandescent, Manual WB, Color Temp. (1900K-10000K)

Flash	Flash Method	Pop-up (Manual)
	Flash Modes	Force Off, Flash Auto, Force Flash, Slow Sync., Slow Sync. + Red-Eye Reduction, Red-Eye Reduction
Recording Media		Internal Memory: Approx. 67MB
		SD / SDHC / SDXC Card (Up to 512GB Support) [MMC Card not supported]
Multi-Language Support		27 Languages
Jacks		USB 2.0 (Micro 5 pin USB)
Power		AA Alkaline Starter Battery (x4), AA NiMH Battery (x4) [Not Include]
Shooting Capability (Battery Performance)		Approx. 300 Shots of AA Alkaline Battery (Based on CIPA Standards)
Operation Environment		Temperature: 0 ~ 40°C, Humidity: 0 ~ 90%
Dimensions (W×H×D)		Approx. 113.6 × 77.7 × 69.7mm (Based on CIPA Standards)
Weight		Approx. 336g (Body Only)

Prompts and Warning Messages

Message	Description	Action
Warning! Battery exhausted.	The camera batteries are depleted. It is a warning indicating that the camera is going to shut off.	Replace the AA batteries. The camera will shut down in 2 seconds.
Lens obstruction, Re-start Camera.	The lens is jammed or some foreign object is preventing the lens from functioning properly.	Turn the camera off and restart it to reset the lens.
Suggest using tripod.	When continuous exposure is enabled, this prompt message is displayed when the photo shooting screen is displayed for the first time.	This message will disappear after 2 seconds.
Battery temperature is too high.	The battery temperature reaches 53.5°C or 128.3°F.	Let the batteries cool before attempting to use the camera again. This message will disappear after 2 seconds
Built-in memory error!	An error has occurred in the internal memory.	Try shutting down the camera and turning it on again. This message will disappear after 2 seconds

Message	Description	Action
Improper alignment. Please try again.	The offset is too big for panorama shooting.	This message will disappear after 2 seconds.
Warning! Do not turn off your camera during update!	This message appears during the firmware update process.	This message disappears after the camera update and restart.
Remove USB cable!!	Indicates that you can disconnect the USB cable.	The message disappears after you disconnect the USB cable.
Connection Failed!	Failure to connect to your computer.	Remove USB cable and retry connection.
Write Protect !	The memory card is locked.	Remove memory card and switch the lever on the side of card to UNLOCK. This message will disappear after 2 seconds.
Card Full !	Indicates that the memory card is full.	Replace memory card with another that has available memory. This message will disappear after 2 seconds.
Memory Full !	Indicates that the camera memory is full.	It will disappear after 2 seconds.

Message	Description	Action
Card Error !	During power-on, the memory card cannot be recognized.	Format the memory card. WARNING: Formatting the memory card will erase all data on the card. Copy the data from the memory card to another storage, such as a computer. Otherwise, all data will be erased after the format. This message will disappear after 2 seconds.
Card is not formatted.	When an error occurs in the memory card, the message "Not Formatted" will appear.	Format the memory card. WARNING: Formatting the memory card will erase all data on the card. Copy the data from the memory card to another storage, such as a computer. Otherwise, all data will be erased after the format.
Slow access!	When a memory card lower than Class 10 is used to record a HD movie, the writing speed will be slower and recording will not continue.	Replace the memory card with a higher Class over 10. This message will disappear after 2 seconds.
Cannot write to SD card.	The photo shooting or video recording has been interrupted, so recording cannot continue.	Turn the camera off. Then unload and reload the memory card and turn on the camera to restart. Also check if memory card is full or in the locked position.
No Red-Eye Detected!	Red eyes have not been detected in the image.	This message will disappear after 2 seconds.

Message	Description	Action
This image cannot be edited.	The file format does not support editing or the edited file cannot be edited again.	This message will disappear after 2 seconds.
Exceeded maximum folder number.	This indicates that the memory card exceeded the maximum number of folders (999). This could cause a long read time during the camera's power up.	Copy the data to your PC and format the memory card using the camera.
Too many pictures for fast processing.	During the playback by date, the images exceed specifications so that it is not possible to play by date.	The message disappears after 2 seconds and the camera returns to normal playback mode.
Unable to recognize files.	The format of the file to be viewed is not supported or the file is corrupted so it cannot be properly read.	This message disappears only after the file is deleted.
No Picture!	When you press the play button, no image files exist in the camera or on memory card.	This message disappears after 2 seconds and returns to the photo shooting screen.
No continuous group file.	When it switches from playback mode to Cont. playback mode, if there is no continuous group file in the files, this prompt message will display.	The message disappears after 2 seconds and the camera returns to normal playback mode.
Protected! Undeletable!	The file is protected. The message appears when you go into delete mode.	Remove memory card and switch the lever on the side of card to UNLOCK. Place card back into the camera and try again. This message will disappear after 2 seconds.

Troubleshooting

Problem	Possible causes	Solution
Camera does not turn on	<ul style="list-style-type: none"> ■ The camera batteries are depleted. ■ The batteries are not inserted correctly. 	<ul style="list-style-type: none"> ■ Replace new batteries. ■ Correctly reinstall the batteries.
Camera turns off suddenly during operation	<ul style="list-style-type: none"> ■ The camera batteries are depleted. 	<ul style="list-style-type: none"> ■ Replace new batteries.
The picture is blurred	<ul style="list-style-type: none"> ■ Camera movement while taking a picture. 	<ul style="list-style-type: none"> ■ Turn on OIS.
Images and video files cannot be saved	<ul style="list-style-type: none"> ■ The memory card is full. ■ The memory card is locked. 	<ul style="list-style-type: none"> ■ Use another memory card or delete unnecessary files. ■ Unlock the memory card.
Saving data to memory card is slow	<ul style="list-style-type: none"> ■ Using a memory card below Class 10 may result in slower recording times. 	<ul style="list-style-type: none"> ■ Use a memory card with Class 10 or higher standard to improve performance.
Cannot write to the memory card	<ul style="list-style-type: none"> ■ The memory card has been locked. 	<ul style="list-style-type: none"> ■ Release the write lock of the memory card or replace with another card.
Too many movies to process	<ul style="list-style-type: none"> ■ The number of pictures or folders in the memory card exceed the specifications, so the playback can not be displayed. 	<ul style="list-style-type: none"> ■ Delete unwanted files.
The flash  flashes on the LCD screen.	<ul style="list-style-type: none"> ■ Current shooting environment requires flash. 	<ul style="list-style-type: none"> ■ Turn on flash.

Memory Card Compatibility

• Cards compatible with this camera (√ : Compatible X: Not Compatible)

	micro SD	micro SDHC	micro SDXC	Conversion adapter to SD card	SD	SDHC	SDXC
Format	FAT12, 16	FAT32	exFAT	-	FAT12, 16	FAT32	exFAT
Capacity	Up to 2GB	4-32GB	64GB-2TB	-	Up to 2GB	4-32GB	64GB-2TB
Compatibility	X	X	X	√	√	√	√

It indicates that the writing speed class will be displayed on the memory card.

Use a memory card with the appropriate writing speed for the video recording mode to be recorded.
(O: Recommended X: Not recommended)

	Speed Class	UHS Speed Class	Video Speed Class	Video Recording			
				4K	FHD	HD	VGA
90MB/sec			V90	O	O	O	O
60MB/sec		UHS-III	V60	O	O	O	O
30MB/sec		UHS-I	V30	O	O	O	O
10MB/sec	Class 10		V10	O	O	O	O
6MB/sec	Class 6			X	X	X	O
4MB/sec	Class 4			X	X	X	O
2MB/sec	Class 2			X	X	X	O

JK Imaging Ltd., 14067 Stage Road, Santa Fe Springs, CA 90670 USA

kodakpixpro.com

Made in Myanmar (Burma)

© 2024 JK Imaging Ltd. All Rights Reserved.

The Kodak trademark, logo and trade dress are used under license from Eastman Kodak Company. All other logos, products or company names that are referred to in this document are trade names, trademarks or registered trademarks of their holders. The holders are not affiliated with JK Imaging Ltd., our products or our website.

Document No/Sequence: U.DIS.0068.0424.en.03

