

Kodak

PIXPRO SP1

Digital Action Cam

User Manual



Before You Start

Declaration of Conformity

Responsible Party: JK Imaging Ltd.

Address: 17239 So. Main Street, Gardena, CA 90248 USA
JK Imaging Europe, 71 Clarendon Road, Watford, WD17 1DS, UK



Company Website: <http://kodakpixpro.com>

For Customers in Canada

This device complies with Industry Canada license-exempt RSS standard(s). Operation is subject to the following two conditions: (1) This device may not cause interference, and (2) this device must accept any interference, including interference that may cause undesired operation of the device.

For Customers in Europe

 "CE" mark indicates that this product complies with the European requirements for safety, health, environment and customer protection. "CE" marked products are intended for sales in Europe.

 This symbol [crossed-out wheeled bin WEEE Annex IV] indicates separate collection of electrical waste and electronic equipment in the European countries. Please do not  throw the equipment into domestic refuse. Please use the return and collection systems available in your country for proper, safe disposal of this product.

For Customers in the U.S.A.

This equipment has been tested and found to comply with the limits for a Class B digital device, pursuant to Part 15 of the FCC Rules. These limits are designed to provide reasonable protection against harmful interference in a residential installation. This equipment generates, uses and can radiate radio frequency energy and, if not installed and used in accordance with the instructions, may cause harmful interference to radio communications. However, there is no guarantee that interference will not occur in a particular installation. If this equipment does cause harmful interference to radio or television reception, which can be determined by turning the equipment off and on, the user is encouraged to try to correct the interference by one or more of the following measures:

- Reorient or relocate the receiving antenna.
- Increase the separation between the equipment and receiver.
- Connect the equipment into an outlet on a circuit different from that to which the receiver is connected.
- Consult the dealer or an experienced radio / TV technician for help.

This device complies with part 15 of the FCC Rules. Operation is subject to the following two conditions:

(1) This device may not cause harmful interference, and (2) this device must accept any interference received, including interference that may cause undesired operation.

Changes or modifications not expressly approved by the party responsible for compliance could void the user's authority to operate the equipment.

About this Manual

Thank you for purchasing this product. Please read this manual carefully and keep it in a safe place for future reference.

- JK Imaging Ltd. reserves all rights to this manual. No part of this published manual may be reproduced, transmitted, transcribed, stored in a retrieval system or translated into any language or computer language, in any form, by any means, without the prior written permission of JK Imaging Ltd. .
- All trademarks mentioned in this manual are used for identification purposes only and are properties of their respective owners.
- This manual provides you with instructions on how to use your new KODAK PIXPRO Digital Action Cam. Every effort has been made to ensure that the contents of this manual are accurate. However, JK Imaging Ltd. reserves the right to make changes without notice.
- Throughout this manual, the following symbols are used to help you locate information quickly and easily:



Indicates useful information.



Indicates precautions are to be taken while operating the product.



Indicates long pressing a certain point.



Indicates tap a certain point.

- In this manual, digital action cam is referred to as action cam.

Safety Notes

Waterproof / Dustproof / Shockproof / Freeze-proof

- JIS / IEC waterproof grade 8 (IPX8).
- JIS / IEC dustproof grade 6 (IP6X).
- Height for shockproof rating is 2.0m.
- Suitable temperature range for freeze proof capability is -10°C and above.

Product Notes:

- Do not disassemble or repair the product by yourself.
- Do not heavily drop or knock this product. Improper handling may damage this product.
- Avoid touching the lens cover and lens element please use professional lens cleaning paper together with lens cleaning agents to wipe the lens and keep the lens clean.
- Do not use corrosive, alcoholic or organic-solvent-containing cleaners to wipe this product.
- Do not use or store this product in high temperature environment.
- Do not expose the lens to strong light sources (e.g. Daylight, etc.) for extended periods of time.
- Do not use or store the product in strong magnetic field environment.
- If the product is quickly transferred from a low temperature environment to a high temperature environment, water condensation may occur in the product due to physical changes. In this case, it is recommended to wait until the product returns to room temperature before you turn it on.
- If a photo or video cannot be played back due to human-caused improper operation, the Company shall assume no liability or responsibility for compensation.
- Store the product in a dry and clean environment when you are going to store the product for a long period of time.

Waterproofing Notes:

- Do not use the product below 10 meters (32.8 feet) underwater. The product will remain waterproof for one hour at the depth of 10m (32.8 feet).
- Do not use this product in a geothermal spring or in water at a temperature greater than 40 °C.
- Please do not open the rear cover underwater.
- If water accidentally comes in contact with the product, please do not open the rear cover immediately. Turn the product off, and dry it with a clean, dry and lint free cloth. Then open the rear cover, and remove the battery and the memory card.
- When opening the rear cover, if there are water drops on the contact surface between the inside of the rear cover and the body, please dry the water drops.
- After using the product in water or near sand, mud or other foreign materials, please rinse it with clean water (close the rear cover when cleaning). After cleaning, dry the product with a clean, dry and lint free cloth.
- If there is dust, sand or other foreign materials on the waterproof rubber of the rear cover and its contact surface, please wipe it with a clean, dry and lint free cloth as soon as possible.
- Before using the product underwater, make sure that there is no damage to or foreign debris on the waterproof rubber gasket. Then close the rear cover tightly to ensure the waterproof capability of the product.



Waterproof rubber with scratches and cracks will allow water to penetrate into the product. Contact customer service immediately for maintenance with replacement of new waterproof rubber.

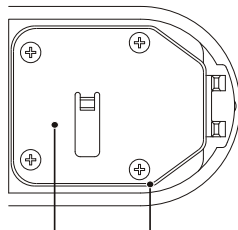

Rear Cover Waterproof Rubber

Battery Notes:

- Use only the battery specified for this product.
- If the battery overheats during charging or use, stop charging or use immediately. Turn off the product, remove the battery carefully, and wait until it cools down.
- Please keep the battery contacts clean and dry.
- Please install the battery according to the positive and negative markings on the battery compartment. Never force it into the battery compartment.
- If battery fluid leaks into the product, please contact your retailer. If battery fluid leaks onto your skin, rinse your skin immediately with clean water and seek for medical attention.
- To prevent the battery from being damaged, do not drop the battery, impact it with heavy objects or scratch it with sharp objects.
- Do not let the battery come in contact with metal objects (including coins) to avoid short circuiting, discharging, excessive heat, or possible leakage.
- Do not heat the battery or throw it into a fire to avoid a possible explosion.
- When the product is stored for a long period of time, please remove the battery.
- Do not store the battery in a hot environment.
- In colder environments, the performance of the battery may be noticeably reduced.
- Do not attempt to disassemble the battery.
- Disposal of used batteries should be carried out in accordance with the local (national or regional) regulations.

Memory Card Notes:

- The memory card referred to in this manual is Micro SD Card or Micro SDHC card.
- Please buy a genuine memory card of a well-known brand.
- Please keep the memory card clean and dry.
- When inserting a memory card, make sure the notch direction of the card matches the notch direction of the memory card mark near the card slot. Do not force the memory card into the card slot.
- Before using a brand new memory card, please format the memory card first.
- A photo or video taken with the product will be stored in the folder that is automatically generated on the memory card. Do not store photos or videos that are not taken using the product in these folders in case that the files cannot be normally recognized in playback.
- Do not directly edit the data on the memory card. Copy the data to your computer disk before editing.
- Do not modify the names of the files or folders on the memory card using your PC. Modifying the name of the files or folders may cause the files to not be recognized by the product or possibly an error may occur.
- Please turn the product off before removing the memory card. Otherwise, the memory card could be damaged.
- When the product is stored for a long period of time, please backup the data on the memory card and remove the memory card for storage.

Other Notes:

- Do not disconnect the power or turn the product off during the update process. Doing so may cause incorrect data to be written and the product may not power on later.
- When using your product on an airplane, observe the relevant rules specified by the airline.
- Due to the limitations of manufacturing technology, the LCD screen may have a few dead or bright pixels. These pixels do no effect the quality of the photos or video.
- If the LCD screen is damaged, pay particular attention to the liquid crystal in the screen. If any of the following situations arise, take the recommended immediate action indicated below:
 1. If liquid crystal comes in contact with your skin, please wipe with a dry cloth, wash thoroughly with soap, and rinse with plenty of clean water.
 2. If liquid crystal gets into your eye, flush the eye immediately with plenty of clean water for at least 15 minutes and then seek for medical assistance.
 3. If liquid crystal is swallowed, immediately flush your mouth thoroughly with clean water and induce vomiting. Seek for medical assistance.

Contents

Before You Start	1
Safety Notes	4
Contents	9
Getting Ready.....	13
Accessories Included.....	13
Part Names.....	15
Installing and Dismantling the Lens Cover	18
Installing Battery and Memory Card	20
Charging	22
Introduction to Various Button Functions	23

Operation Method.....	25
Turn On / Off	25
Set your Language, Date and Time after the first power-on	26
LCD Screen Display	27
Introduction to Basic Operation of Recording and Shooting	28
LCD Screen Display under Playback Status	30
Introduction to Basic Operation of Playback.....	31
Introduction to the Setting Mode of Menu Options	36
Menu Introduction	37
Introduction to General Settings	38

Introduction to Mode Settings	43
Movie Settings Introduction	44
Still Settings Introduction	51
AP Settings Introduction	54
Connecting the Camera with the Smart Device.....	57
Download and Install App	57
Establish a Connection	58
Smart Device APP Operating Method	59
Position Service Function	59
Remote Viewfinder.....	59

Playback	67
Connection Port Introduction	82
Connect a Computer.....	82
HDMI Connected TV Output.....	84
Appendices.....	85
Specifications.....	85
Prompts and Warning Messages.....	88
Trouble Shooting.....	92
Special Accessories.....	93

Getting Ready

Accessories Included

Your product box should contain the product you purchased along with the following accessories. If anything is missing or appears to be damaged, please contact your retailer. (Based on sales in different countries or regions, the shape of the AC adapter will vary. The actual product will prevail.)



Quick Start Guide



Service Card



Warranty Card

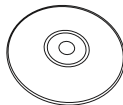

CD-ROM

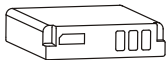

Rechargeable
Li-ion Battery

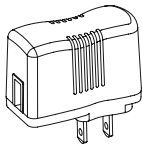

AC Adapter



USB Cable

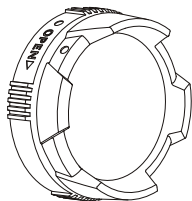

Standard Lens Cover

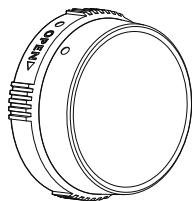

Underwater Lens Cover



Standard Lens Cover has been installed on the product when leaving factory.

Part Names

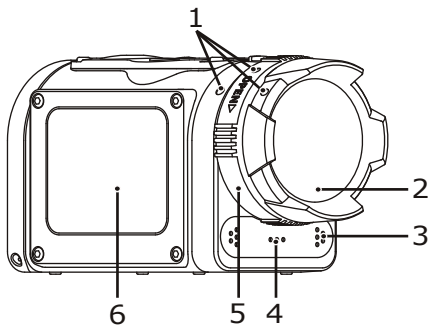

1	Alignment Point
2	Standard Lens Cover
3	Microphone
4	Speaker
5	Lens Cover Ring
6	LCD Screen

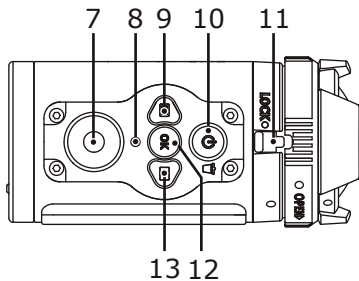

7	Video Recording Button / Shooting Button
8	Status Indicator
9	Menu Button / Direction Button (Upper)
10	Power Button / Delete Button
11	Lens Cover Buckle
12	OK Button
13	Playback Button / Direction Button (Lower)

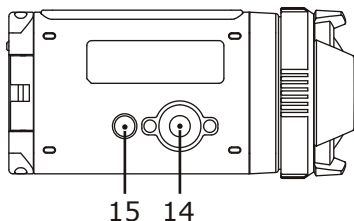

14	Tripod Socket
15	Location Hole

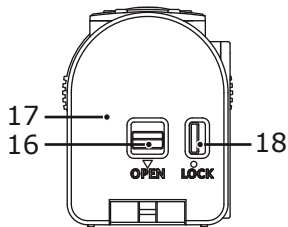

16	Rear Cover Open Switch
17	Rear Cover
18	Rear Cover Lock

Rear Cover Open Status

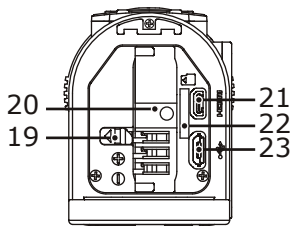

19	Battery Lock
20	Battery Compartment
21	HDMI Port
22	Micro SD Card Slot
23	USB Port

Installing and Dismantling the Lens Cover

Two types of replaceable lens covers are provided for the product.

Standard Lens Cover:

Applicable for general use. Do not use underwater.

Visual angle in the air is about 160° . Will not focus underwater.



Underwater Lens Cover:

Applicable for use in water.

Visual angle in the air is about 130° , and visual angle in water is about 90° .

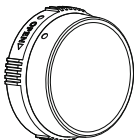

Steps for dismantling the lens cover:

1. Hold the product with your left hand, and pull the lens buckle with your finger to the left end as illustrated in the picture. Hold the lens cover ring with your right hand and rotate to the OPEN arrow direction.
2. When three alignment points are in a straight line, loose your left hand from the lens buckle, and remove the lens cover from the right with your right hand.

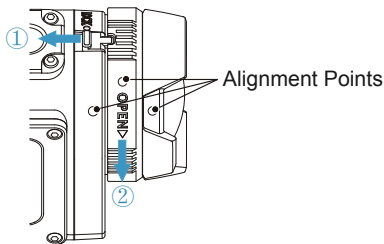

Steps for installing the lens cover:

1. Hold the product with your left hand, and pull the lens buckle with your finger to the left end as illustrated in the photo, hold the lens cover ring with your right hand.
2. When three alignment points are in a straight line, buckle the lens cover to the lens, and rotate against the OPEN arrow direction.
3. When the notch of the lens cover ring is aligned with the lens buckle, loose your left hand from the lens buckle, and remove your right hand from the lens cover.

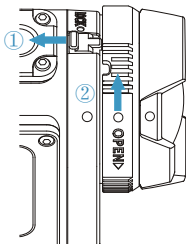

- ① Please select appropriate lens cover when taking videos and pictures, otherwise it will affect the image effect.
- ① When the product is exposed to fluctuations in temperature, condensation may form on the inside surface of the lens cover. If this happens, remove the lens cover, clean it with a soft, dry, lint-free cloth, and then reinstall the lens.

Installing Battery and Memory Card

1. Open the rear cover

First, set the rear cover lock to the right, and push the open switch of the rear cover downward. Then rotate the rear cover around the shaft direction to open upward.

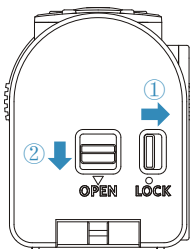

2. Insert the battery into the battery compartment according to the negative and positive directions as illustrated in the following picture.

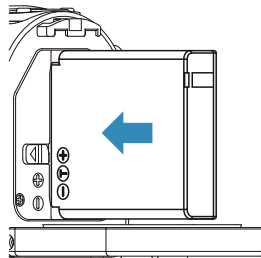

3. Insert the memory card into the card slot according to the direction illustrated in the picture when the product is turned off. When inserting a memory card, make sure the notch direction of the card matches the notch direction of the memory card over the card slot. Do not force the memory card into the card slot.

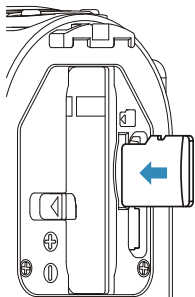

4. Close the battery cover

First, rotate the back over around the shaft direction to close upward. The rear cover will “click” when tightly closed. Finally, move the rear cover lock to the left.

- Memory card (refers to Micro SD card or Micro SDHC card) is optional, which is not included in the product package and needs to be purchased separately. Please purchase a genuine memory card with a storage capacity range of 4GB to 32GB, in order to ensure the safe preservation of data. It is recommended to use a memory card of Class 4 or higher.
- To remove the memory card, please open the rear cover and gently push the memory card. After it is ejected, remove the card carefully.
- The product will automatically turn off if the memory card is inserted and extracted when the product is on.

Charging

Please charge after the product is turned off.

1. Connect the product to the AC adapter with a USB cable.
2. Then insert the plug of the AC adapter to the power outlet for charging.

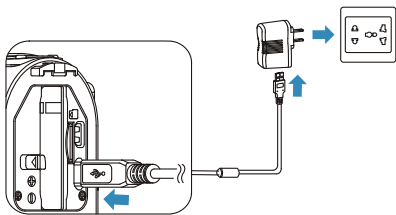

- After the battery is stored for a long period, use the supplied AC adapter to charge the battery prior to use.
- You may use external power supplies (output voltage of 5V, output current of 1A), namely vehicle power supply or mobile power pack to charge the product.

3. You can also connect the product to your computer with a USB cable to charge the battery. If you press and hold the power button (⏻) during charging to turn off the product, the charging will be stopped.



Charging indicator:

Red flash: Charging

The indicator will go out once charging is finished, and the Action Cam will be powered off automatically.



To have maximum battery life, charge the battery for at least 4 hours the first time.



Please charge the battery indoors between 0°C and 40°C.



If connected to the computer USB port of 100mA, the product will have no response due to insufficient power.





Introduction to Various Button Functions



Viewfinder status refers to viewfinder of recording and shooting.







To save power, if the product is not operated for a period, it will automatically enter the LCD off status. Press any button can wake LCD.

Button	Name	Menu Status	Viewfinder Status	Recording
	Power Button / Delete Button	No action	Display all information when the it is hidden	No action
		Press and hold: turn off the product		
	OK Button	Confirm selection	Recording mode / Shooting mode switch	No action
	Menu Button / Direction Button (Upper)	Switch upward	Enter menu	No action
	Playback Button / Direction Button (Lower)	Switch downward	Enter single photo status	No action
	Video Recording Button / Shooting Button	Enter viewfinder status (except Wireless feature)	Start recording / Shooting a photo	Stop recording





In the viewfinder status, when the Motion detection or Time Lapse function is set to be enabled, press  to enter the state of preparing for video recording.

Button	Name	Single Photo	Movie Playback		
			Playing Back	Fast Forwarding / Rewinding	Pausing
	Power Button / Delete Button	Delete	Back to the initial state of the movie		
		Press and hold: turn off the product			
	OK Button	Photo file: no action Movie file: start playback	Pause	Normal speed playback	Continue to play back
	Menu Button / Direction Button (Upper)	Previous File	Rewind	Rewind	Previous Frame
	Playback Button / Direction Button (Lower)	Next File	Forward	Forward	Next Frame
	Video Recording Button / Shooting Button	Enter viewfinder status	No action		

Operation Method

Turn On / Off

Turn on:

When the power is off, press and hold  for more than 2 seconds to turn on the product; or press and hold  for more than 2 seconds to turn on the product and enter the playback status.













Turn off:

When the power is on, press and hold  for more than 2 seconds to turn off the product.



If the product cannot be turned on / off normally, you can remove the battery for forced power cut.

Set your Language, Date and Time after the first power-on



1. Press and hold the  to turn on the product and enter the language selection screen;
2. Press  or  to select language;
3. After pressing  button to select desired language, the product will enter [Date / Time] setting screen;
4. Press  or  to adjust the date and time display format, and press  to confirm the display format;
5. In the date and time options, press  or  to adjust the values, and press  to confirm;
6. After confirming, automatically go to , and press  to confirm, and enter the viewfinder status.

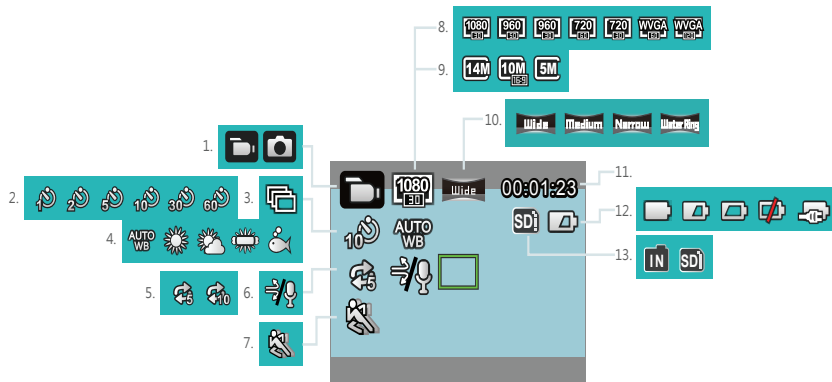

LCD Screen Display



- | | |
|-----------------------------|--|
| 1. Mode Display | 8. Movie Size Display |
| 2. Time Lapse Display | 9. Still Size Display |
| 3. Burst Shot Display | 10. Field of View Display |
| 4. White Balance Display | 11. Remaining Recording Time Display / Number of remaining shots Display |
| 5. Loop recording Display | 12. Battery Status Display |
| 6. Wind Cut Display | 13. Internal Memory / Memory Card Display |
| 7. Motion detection Display | |

 Some icons will automatically hide after a 2 second display. Press  to display all current setting Message.

  Indicates 16:9 display range.

  Indicates 4:3 display range.

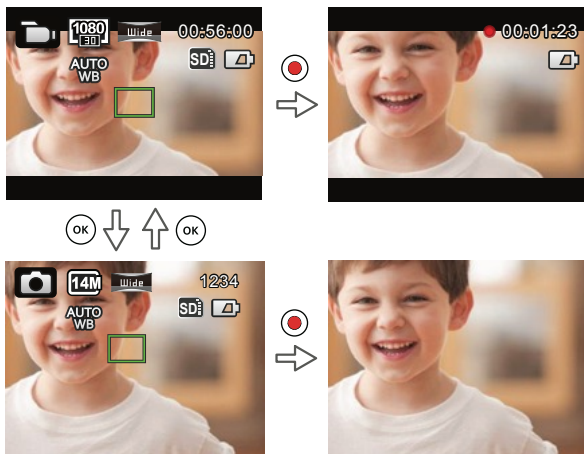

Introduction to Basic Operation of Recording and Shooting

1. Enter the viewfinder status mode, and press **OK** to switch between recording mode and shooting mode;
2. Align the lens to the object to be recorded, and press **REC** for recording or shooting;
3. Under the recording mode, repress the **REC** to stop recording.

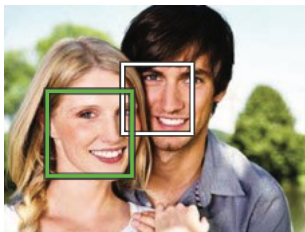

Under shooting mode status, when the product detects a human face, a green focus frame will appear. When two or more human faces are detected, a green main focus frame and a white secondary focus frame will appear.





-  When the product rotates around the lens axis for 180°, the display screen on the LCD is positive display.
-  When in still and video record mode, the LCD may turn off to save power. Pressing  will turn on the LCD and immediately initiate / terminate recording. Pressing any other button will only turn on the LCD.

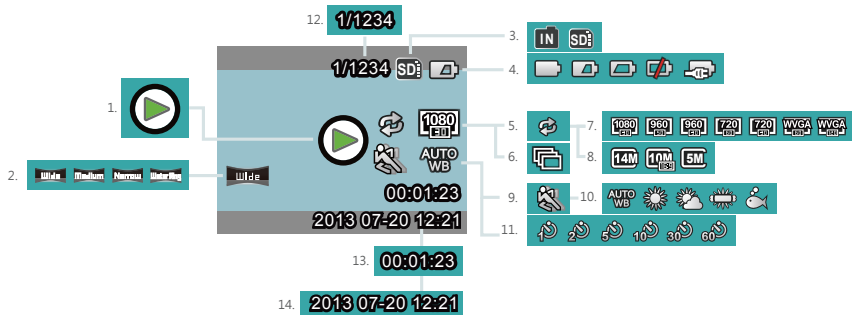

LCD Screen Display under Playback Status





1. Movie Display
2. Field of View Display
3. Memory Card or Internal Memory Display
4. Battery Status Display
5. Loop recording Display
6. Burst Shot Display
7. Movie Size Display
8. Still Size Display
9. Motion detection Display
10. White Balance Display
11. Time Lapse Display
12. Display of Current number of Shots / Total Number of Shots
13. Movie Time Length Display
14. Shooting Time and Date Display

 Some icons will automatically hide after a 2 second display.



  Only displayed when playing back the movie file.

  Indicates 16:9 display range.

  Indicates 4:3 display range.

Introduction to Basic Operation of Playback

Single Photo:

1. When in viewfinder status mode, press  to enter the playback status of video and pictures;
2. Display movie or picture files on the LCD screen;
3. Press  or  to view the movies or pictures stored in the memory card or internal memory.



Press  to return to the viewfinder status.



When the memory card is inserted, only files in the memory card will be displayed, files on internal memory will not be available to display.



If there are no files in the memory card or internal memory, a no image warning window will appear.

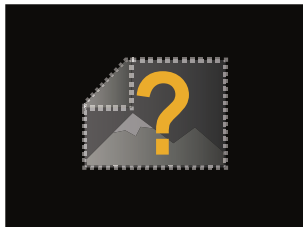

Movie Playback:

1. Select movie to be played back, and press **OK** to start movie playback.

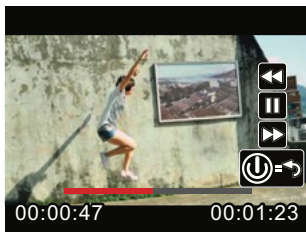

2. When playing back the movie, an operation guidance will appear on the screen. You can press buttons to perform the corresponding functions.

Press **⏮** : Movie playback rewind, multiple presses will fasten the speed: x2 / x4 / x8 / x16

Press **⏪** : Movie playback forward, multiple presses will fasten the speed: x2 / x4 / x8 / x16

Press **⏸** : Under normal playback mode, the movie playback will be paused; under the forward, rewind or pause status, normal speed playback will be recovered

Press **⏹** : Movie playback back to the initial state

Movie playback rewind or forward:

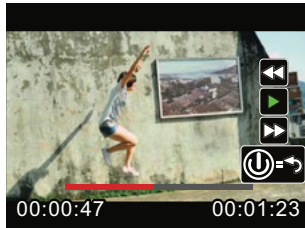





Movie playback pause:





There will be no sound output during rewinding or forwarding.

Movie or Picture Delete:

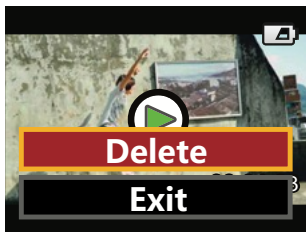
1. Select the movies or photos to be deleted, and press  to enter the Delete screen. Press  or  to select [Delete] , and press  to confirm.
2. After a movie or a photo is successfully deleted, the LCD will display the next movie or photo. If you wish to delete additional files, please continue per item 1 above.
3. If you want to exit the Delete screen, select [Exit] , and press  to confirm.



 Movie and / or pictures cannot be restored after being deleted.

 A protected file cannot be deleted.

Rotation:

The direction sensor comes with the product can automatically adjust the direction during file playback according to the rotating direction detected during shooting, in order to ensure that what you see are positive images.











The direction of rotation refers to the direction rotating around the lens center clockwise or counterclockwise. Only when the direction sensor detects that the product has rotated for 180°, the rotation feature is effective. Rotation of 90° or 270° is invalid.



The product will record the detected 180 ° rotation information in a file. When you use a player supporting rotation tag identification (such as Quick Time) for playing, the image can be automatically converted to positive.

Introduction to the Setting Mode of Menu Options

1. Under the viewfinder status, press  to enter first-level menu interface of the menu;
 2. Press  or  to select [Mode Settings] , [Movie Settings] , [Still Settings] , [AP Settings] and [General Settings] ;
 3. Press  to confirm, and to enter the corresponding secondary level menu interface;
 4. Select items with * on the secondary level menu, and press  to confirm and to enter the tertiary menu interface;
 5. Select [Movie] or [Shot] or [Exit] in the secondary menu, and press  confirm to back to the first level menu interface.
-  In the menu interface (except for the Wireless connecting status), press  to return to the viewfinder status.

Menu Introduction

First Level Menu	Mode Settings	Movie Settings	Still Settings	AP Settings	General Settings
Secondary Level Menu	Movie	* Movie Size	* Still Size		* Sound Settings
	Shot	* Time Lapse	* Burst Shot		* Power Off
		* Loop recording	* Field of View		* Wireless Power Saving
		* Field of View	* White Balance		* Date / Time
		* Motion detection	Exit		* Language
		* Wind Cut			* Format
		* White Balance			* Copy to Card
		Exit			* Reset Settings
					* FW Version
					Exit

Introduction to General Settings

10 options in the [General Settings] of the first level menu:

- [Sound Settings]
- [Power Off]
- [Wireless Power Saving]
- [Date / Time]
- [Language]
- [Format]
- [Copy to Card]
- [Reset Settings]
- [FW Version]
- [Exit]

Sound Settings

There are 4 options in the [Sound Settings] :



Power Off

Power Off means the product will automatically shut down after 60 seconds after the LCD is off.

There are 2 options in [Power Off] :

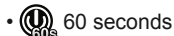



The Power Off will be invalid during recording, movie playing back and wireless connecting.

Wireless Power Saving











Wireless Power Saving mode means that after 30 seconds of remote-controlled recording with the APP, the wireless connection will automatically disconnect, but the product will continue to record. Wireless power saving mode will prolong battery life.

There are 2 options in [Wireless Power Saving] :

-  Off
-  Enable





Date / Time

Date and time can be set during the first power on cycle. If you wish to change the date or time thereafter, please operate as the following.

1. Enter the [Date / Time] in the secondary level interface and press  to confirm;
2. Press  or  to adjust the date and time display format, and press  to confirm the display format;
3. In the date and time options, press  or  to adjust the values, and press  to confirm;
4. After the setting is completed, select , and press  to confirm and back to [Date / Time] in the secondary level interface;
5. Press  to return to the viewfinder status.

Language



The language can be set during the first power on cycle. If you wish to change the language thereafter, please operate as the following.

1. Enter the [Language] in the secondary level interface and press  to confirm;
2. Press  or  to select language;
3. Press  to confirm and back to [Language] in the secondary level interface;
4. Press  to return to the viewfinder status.

Format

Format can clear all data stored in the memory card or memory (including protected movies and photos).

There are 2 options in [Format] :

-  Cancel
-  Confirm



When a memory card is inserted, only the card can be formatted. If you need to format the internal memory, remove the memory card first.

Copy to Card

Copy to Card is to copy the files in the internal memory to the memory card

There are 2 options in [Copy to Card] :

- Cancel
- Confirm



When the memory card cannot be detected by the product, options will not be displayed on the [Copy to Card] interface.

Reset Settings

Reset Settings can recover all product settings to the factory defaults.

There are 2 options in the [Reset Settings] :

- Cancel
- Confirm

FW Version

FW Version can display the current version.

When a new version is stored in the memory card, the firmware can be updated.

There are 2 options in 「Update firmware?」 :

- ✕ Cancel
- ✓ Confirm





The following operation needs to be followed to update the firmware:

1. Enter the FW Version interface, and press **OK** to enter the tertiary level menu 「Update the firmware?」. LCD will display 「New version: X.XX」;
2. Select **✓**, and press **OK** to confirm. The product will start to update;
3. Whether the update is successful or failed, the product will automatically shut down.







 If the low battery warning is displayed, charge the battery before updating the firmware.





Introduction to Mode Settings

2 options in the [Mode Settings] of the first level menu:

-  [Movie] : for recording movies
-  [Still] : for shooting photos

Mode Settings method of operation:

1. After selecting  or  options, press  to confirm.
2. Press  to enter the viewfinder status, and display your selected  or  status.

 Under the viewfinder status, directly press , to perform  or  status switch.

Movie Settings Introduction

There are 8 options in First Level menu [Movie Settings] :

- [Movie Size]
- [Time Lapse]
- [Loop recording]
- [Field of View]
- [Motion detection]
- [Wind Cut]
- [White Balance]
- [Exit]

Movie Size

Movie Size refers to the image resolution during recording.

There are 7 options in [Movie Size] :

- [1080p30] : 1920×1080 (30fps)
- [960p50] : 1280×960 (50fps)
- [960p30] : 1280×960 (30fps)
- [720p60] : 1280×720 (60fps)
- [720p30] : 1280×720 (30fps)
- [WVGA60] : 848×480 (60fps)
- [WVGA120] : 848×480 (120fps)



When selecting [WVGA120] , the product shoots ultra high speed movies, and plays back with normal 30 fps speed, in order to capture visually indistinguishable moments easily.



When selecting [WVGA120] , the maximum recordable time is 60 seconds, when the time reaches 60 seconds, the product will automatically stop recording and return to the viewfinder state.



When selecting [WVGA120], the sound cannot be recorded.



When selecting [WVGA120], [Time Lapse], [Loop recording] or [Motion detection] cannot be enabled.



When selecting [WVGA60], [Time Lapse] or [Loop recording] cannot be enabled.







The maximum recording time of a 4GB memory card:

Movie Size	Memory card volume	The maximum recording time is about
1080p30	4GB	32 minutes
960p50	4GB	32 minutes
960p30	4GB	50 minutes
720p60	4GB	35 minutes
720p30	4GB	64 minutes
WVGA60	4GB	64 minutes
WVGA120	4GB	35 minutes



Time Lapse

Time Lapse enables the recording of an interval of time, and splices the frames together to present a condensed video which usually requires a long period of time to complete.

There are 7 options in [Time Lapse] :

-  Off
-  1 second
-  2 seconds
-  5 seconds
-  10 seconds
-  30 seconds
-  60 seconds

Time Lapse method of operation:

1. After selecting Time Lapse time, press  to back to the viewfinder status. LCD will display corresponding icons;
2. Press , the LCD will display red font time countdown;
3. Press  again to finish recording.



 Movie Size cannot be selected as WVGA120 or WVGA60.



 The sound cannot be recorded.

 When Loop recording or Motion detection is enabled, the Time Lapse feature cannot be used.



Loop recording

Loop recording allows for the recording of independent segments of movies according to selected time length from the beginning of recording. The product will continually record movies of the length selected until the record button is pressed to end recording. When the memory card is full, the product will overwrite the recorded files starting from the first movie circularly.





There are 3 options in [Loop recording] :

-  Off
-  5 minutes
-  10 minutes

Loop recording method of operation:

1. After selecting Loop recording time, press  to return to the viewfinder status. LCD will display corresponding icons;
2. Press  to start recording;
3. Press  again to finish recording.



-  Movie Size cannot be selected as WVGA120 or WVGA60.
-  When Time Lapse or Motion detection is enabled, the Loop recording feature cannot be used.
-  Loop recording feature can only be used when there is a memory card in the product.
-  Turn off the product when the Loop recording function is enabled and then restart the product. You'll find the Loop recording function is still enabled.



Field of View

Field of View means the image receiving angle for the product.

There are 4 options in [Field of View] :

-  Ultra Wide
-  Medium
-  Narrow
-  Water Ring

Field of View method of operation:

1. After selecting the Field of View angle, press  to return to the viewfinder status. LCD will display corresponding icons;
2. Press  to start recording;
3. Press  again to finish recording.





Medium or Narrow can only be selected when the Movie Size is set to [1080p30] . If a Movie Size other than [1080p30] is selected under Medium or Narrow status, the product will automatically set the Field of View to Ultra Wide.



Motion detection

Motion detection means that if the product detects moving objects entering into the LCD screen, it will automatically start recording. During the recording process, if there is no moving object detected for 10 continuous seconds, the recording will be automatically paused.

There are 2 options in [Motion detection] :

-  Off
-  Enable

Motion detection method of operation:

1. After the Motion detection is enabled, press  to back to the viewfinder status. LCD will display corresponding icons;
2. Press , if the product detects moving objects, it will automatically start recording;
3. The product will stop recording when there is no change in the image within 10seconds;
4. When the image changes again, the product will start recording automatically, and this time it will regenerate a video file;

5. During recording, you may press the  to stop recording.

 When the Motion detection feature is enabled, Time Lapse or Loop recording setting cannot be performed.

 Movie Size cannot be selected as WVGA120.

 Motion detection interface icon:

- ① Indicates the total time of recording
- ② Indicates the time of the product
- ③ Indicates the total time from the beginning of recording



 When the memory card is full, ① will become red font and flashes for 2 seconds.



Wind Cut



Wind Cut refers to the reduction of noise caused by wind.

There are 2 options in [Wind Cut] :

-  Off

-  Enable

Wind Cut method of operation:

1. After the Wind Cut is enabled, press  to return to the viewfinder status. LCD will display corresponding icons;
2. Press  to start recording;
3. Press  again to finish recording.

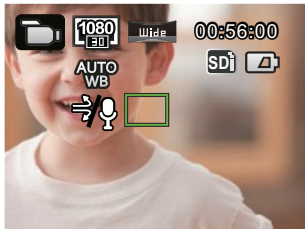

White Balance

White Balance means that the user adjusts the color temperature under different light sources to ensure that the colors are reproduced correctly.

There are 5 options in [White Balance] :

-  AWB



-  Daylight

-  Cloudy

-  Fluorescent

-  Underwater

White Balance method of operation:

1. After the White Balance is enabled, press  to return to the viewfinder status. LCD will display corresponding icons;
2. Press  to start recording;
3. Press  again to finish recording.

Still Settings Introduction

There are 5 options in First Level menu [Still Settings] :

- [Still Size]
- [Burst Shot]
- [Field of View]
- [White Balance]
- [Exit]

Still Size

The Still Size indicates the number of pixels used to capture the images. A photo having higher image resolution contains more details and is capable of better meeting big-screen fine photo printing requirements.

There are 3 options in [Still Size] :

- [14MP] : 4320×3240(4:3)
- [10MP] : 4320×2432(16:9)
- [5MP] : 2592×1944(4:3)

Number of photos that can be stored on a 4GB memory card:

Still Size	Memory card volume	Approximate maximum number of images
14MP	4GB	913 shots
10MP	4GB	1211 shots
5MP	4GB	2398 shots



Burst Shot

Burst Shot allows ten photos to be captured continuously one single time before auto pause.

There are 2 options in [Burst Shot] :

-  Off
-  Enable

Burst Shot method of operation:

1. After Enable in Burst Shot is selected, press  to return to the viewfinder status, LCD will display corresponding icons;
2. Press  to enable Burst Shot shooting. It will stop after 10 photos are taken.



Field of View

Field of View means the image receiving angle range of the product.

There are 4 options in [Field of View] :

-  Ultra Wide
-  Medium
-  Narrow
-  Water Ring

Field of View method of operation:

1. After selecting the Field of View angle, press  to return to the viewfinder status. LCD will display corresponding icons;
2. Press  to shoot.







When the image size is set to [5MP] , Medium and Narrow cannot be enabled.



White Balance

White Balance means that the user adjusts the color temperature under different light sources to ensure that the colors are reproduced correctly.

There are 5 options in [White Balance] :

-  AWB (Auto White Balance)
-  Daylight
-  Cloudy
-  Fluorescent
-  Underwater

White Balance method of operation:

1. After an option of the White Balance is selected, press  to return to the viewfinder status. LCD will display corresponding icons;
2. Press  to shoot.

AP Settings Introduction



The action cam can be wirelessly connected with your smart device.

Please review the following items before your first connection:

1. Your smart device system version needs to be iOS 7 or higher and Android 4.2 or higher. If not, please upgrade your smart device system version.
2. Please do not use in places having high intensity magnetic field, electrostatic and electric wave interference (for example near a microwave oven), which may cause failure in receiving signals.
3. Please maintain a distance between the action cam and the smart device less than 10 meters (32.8 feet) without signal shielding interference.
4. Please do not use wireless connection functionality on a plane.
5. The action cam and the smart device can only be connected one to one.
6. When the smart device judges the system to be out of memory, the App will not be able to run normally. Please clean up the memory of the smart device.
7. When the temperature of the battery is higher than 68 °C :
 - ① AP setting cannot be enabled;
 - ② Wireless connection will be automatically disconnected.

Connection setting method of the product and the smart device:

Step 1: setting up the product

1. Press  in the viewfinder status, select [AP Settings] , and press  to enable wireless connection function so that the SSID interface in [AP mode] appears. SSID and WPA2 password messages are displayed in the interface.





Wireless connection process takes about 30 seconds. At this moment, except for  , other buttons are deactivated.

Step 2: setting up the smart device

1. Enable the wireless function of the smart device to search surrounding wireless devices;
2. Select the name of the action cam to be connected (PIXPRO-SP1_XXXX), and input the eight-digit digital password displayed next to WPA2-PSK on the action cam;
3. Download the special APP installation package (APP name: PIXPRO SP1) from the device appropriate APP store, and install;
4. Click the icon of the APP  to enable the APP.

Step 3: set up completion

1. Once the APP is connected to the action cam, functional operations can be enabled on the smart device. If there is a need to interrupt the connection, press  , so that the selection interface appears, select  , press  , interrupt connection, and return to the SSID interface;

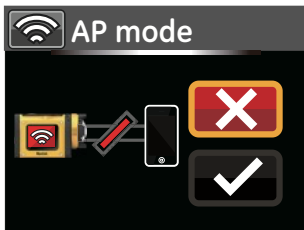
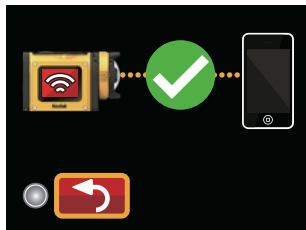

2. If connect APP failed, press \odot to return to the SSID interface, select \curvearrowright , press \odot , so that the selection interface appears, select \checkmark , press \odot . This will change the WPA2 password. Next, perform connection operation again on the smart device;

3. If there is a need to turn off wireless, press \odot button or press \odot after selecting OFF in the SSID interface so that the selection interface appears. Select \checkmark , press \odot to turn off wireless.

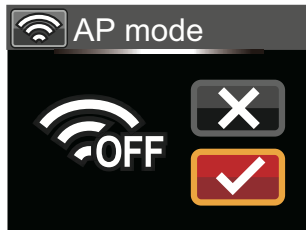

Connecting the Camera with the Smart Device

Download and Install App

Please download App installation package (App name: PIXPRO SP1)  to your smart device from the path below and install it.

- **Android system** 

For Android devices, search and download the App “PIXPRO SP1” in Google play, and install it following the instructions on the interface.



<https://play.google.com/store/Apps/details?id=com.jkimaging.pixproremoteviewer>

- **iOS system** 

For Apple devices, search and download the App “PIXPRO SP1” in App store, and install it following the instructions on the interface.







<https://itunes.apple.com/us/App/pixpro-remote-viewer/id833154167?mt=8>



After successful installation, this icon  will appear on the smart device screen.

Establish a Connection

Wi-Fi Connections (iOS System and Android System)

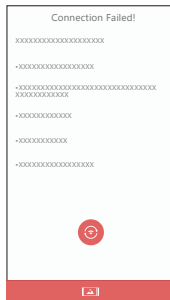
-  To optimize Wi-Fi performance, please close other unnecessary programs running on the smart device.
-  For an Android system smart device, you can directly tap the App icon  to enter the "Select connecting device" screen. Select the SSID name of the camera to be connected, enter an eight-digit password, and tap "Connect".
-  If connection fails, tap  to try to reconnect.



-  When it is unnecessary to connect to the camera or unable to connect the camera, tap the icon  on the screen of the smart device to perform related operations under the playback mode of the smart device.



Smart Device APP Operating Method

Position Service Function

When connected successfully, you can tap the App icon () to start it. Enable the GPS function on the smart device by following the prompts on the interface, PIXPRO SP1 can record GPS location on picture files. This function is not available for video files.

Remote Viewfinder

After finishing setting position service, the App will enter the viewfinder interface. Camera functions can be accessed from this screen.

 On the Remote Viewfinder interface, tap  White balance icon to hide, and tap  to restore display.

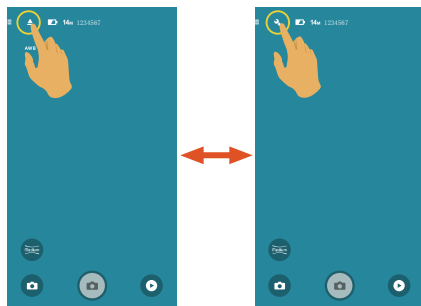

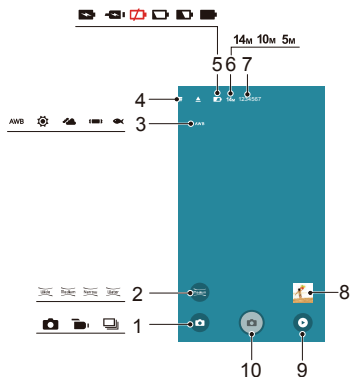

Remote Viewfinder Interface

Shooting Interface

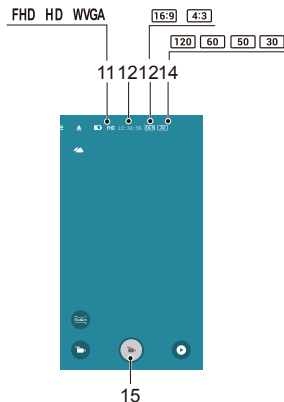

Movie Interface



1	Shooting mode	6	Image size	11	Movie size
2	Angle	7	Number of photos that can be taken	12	Recordable video time
3	White balance	8	Quick Review	13	Pixel ratio
4	Menu	9	Playback mode	14	Frame rate
5	Battery state	10	Shutter	15	Start video recording  / Stop video recording 

Parameter Settings



Tap the icon to enter the selection screen, and tap any of the options to confirm selection.

Shooting Mode

There are 3 options:

Continuous Shot

It can take several photos at a time.

Movie Mode

Enables video recording.

Auto Mode



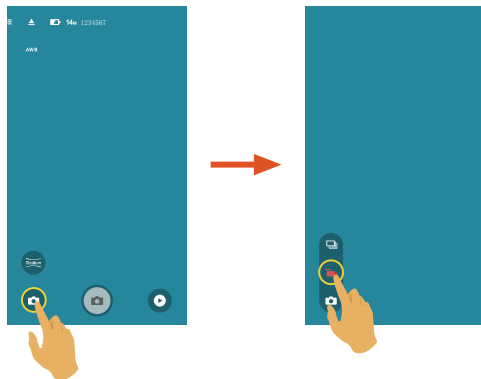

Enables photo shooting.



White balance

The WB function allows the user to adjust color temperatures under different light sources, so as to confirm that the color can be presented properly.

There are 5 options:

- **AWB** AWB
-  Daylight
-  Cloudy
-  Fluorescent
-  Underwater

Angle



Field of view sets the viewing angle.

There are 4 options:

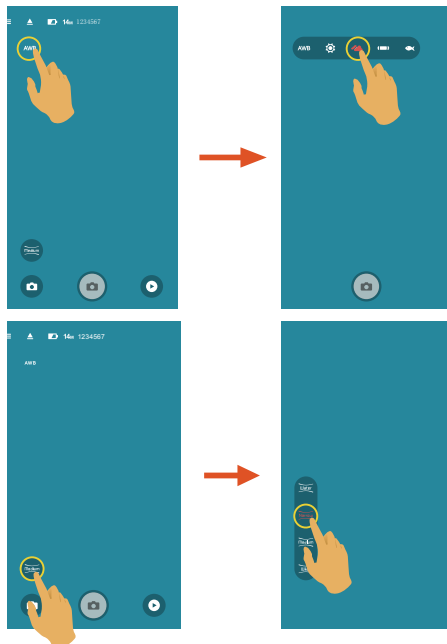
-  Ultra Wide
-  Medium
-  Narrow
-  Water Ring



Menu

Tap  to show a settable menu. Tap the menu items to be set to enter the item options screen. Tap options to return to the menu screen. Tap  to return to the Remote Viewfinder screen.

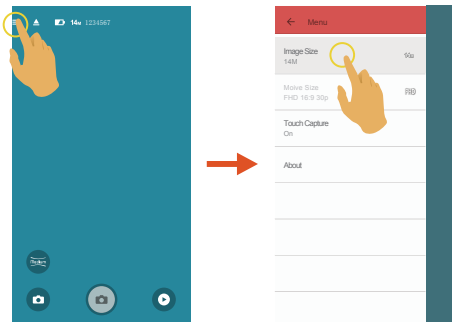

Image Size

Set photo resolution.

Icon	Pixel ratio	Image Pixel
14M	4:3	4320×3240
5M		2592×1944
10M	16:9	4320×2432

Movie Size

Set video resolution.

Icon	Pixel ratio	Movie Size	Recording Time Restraint
FHD	16:9	1920×1080 30fps	The maximum recordable time is 25 minutes.
HD	4:3	1280×960 50fps	
		1280×960 30fps	
	16:9	1280×720 60fps	
		1280×720 30fps	
WVGA	16:9	848×480 60fps	None
		848×480 120fps	The maximum recordable time is 60 seconds.



Select 120fps as the frame rate of movie size to carry out high-speed video recording. The product shoots ultra high speed movies, and plays back with normal 30fps speed, in order to capture visually indistinguishable moments easily. But the sound cannot be recorded.

Touch Capture (Photo shooting mode)

There are 2 options:

- On
- Off

About

- View the current version of the App.
- Tap the official website on the interface and you can go to the website for more information.

Shooting Method



All files are saved on the memory card of the camera.

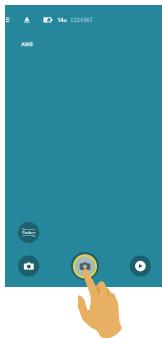

Shooting

1. Align the camera lens with the shooting subject, and confirm viewing through the screen of the smart device.
2. Tap the other icons on the interface to set the corresponding parameters.
3. Tap  to shoot photos.





Video Recording

Tap the shooting mode icon on the shooting screen to enter the mode selection screen, and tap  to enter the video recording screen.

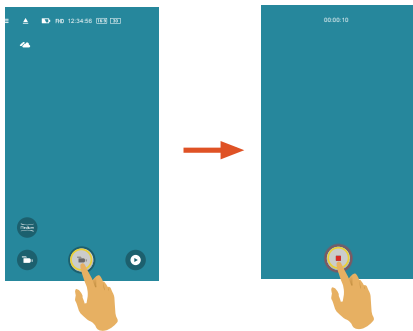
1. Tap the other icons on the interface to set the corresponding parameters.
2. Tap  to start recording and then tap  to stop.



 In Wireless power saving enabled state, a prompting message about breaking of wireless connection in 30 seconds will be popped up when video recording on the smart device. At this moment, if the user does not stop video recording, wireless online will be automatically disconnected, and the wireless disconnection message will be displayed while video recording is continued on the camera.



 Stop video recording and lower the temperature of smart device in case the smart device's temperature is too high. When the high temperature reaches the limit, the smart device automatically stops video recording and shuts down after saving the files.

Playback

There are two playback modes:

- Single playback (movie / photo)
- Index playback (action cam/smart device)

Switching of the Remote Viewfinder Mode and the Playback Mode

1. Tap  to enter the camera single playback interface.
2. Tap  to enter the index playback interface.
3. Tap any small figure to enter the single playback interface.
4. Tap  to enter the remote viewfinder interface.

Remote Viewfinder interface

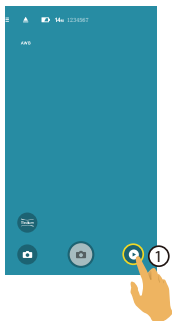



Single playback interface

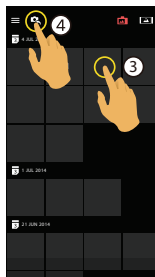

Index playback interface



Switching Camera and Smart Device Index Playback

1. On the camera index playback interface, tap  to enter into the smart device index playback interface.
2. On the smart device index playback interface, tap  to enter into the camera index playback interface.

Camera
index playback interface

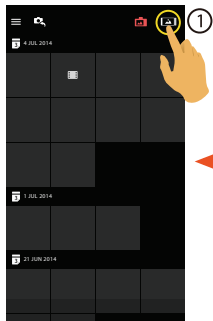

Smart device
index playback interface

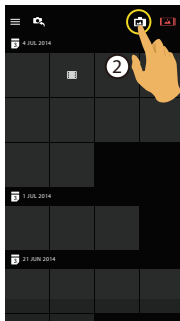

On the smart device index playback interface, tap a small figure to enter into the smart device single playback interface.



On the camera index playback interface, tap a small figure to enter into the camera single playback interface.

Introduction of the Icons in the Playback Mode

Single Playback

Action cam

Photo playback
interface



Video playback
interface

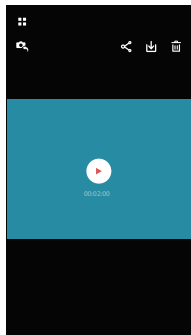







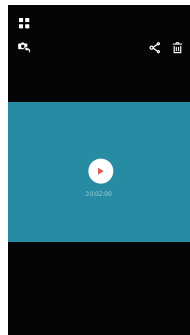

Smart device

Photo playback
interface



Video playback
interface



 Enter index playback screen	 Enter photo or movie mode
 Share the current photo or video to social networks	 Download the current photo or video to the smart device
 Delete the current photo or video	 Rotate the photo
 Play the video	





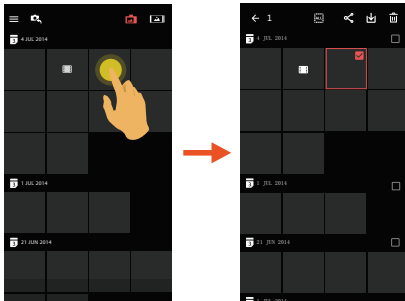

Index Playback

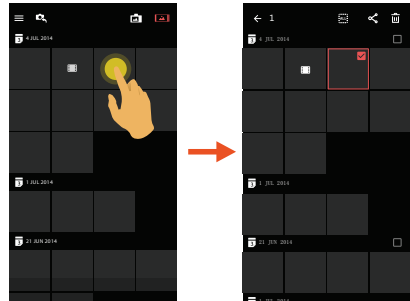
Action cam 



Smart device 



 Menu	 Return to the previous interface
 Enter photo or movie mode	 Select multiple files to share
 Enter the download mode to move the files in the camera into the smart devices	 Select multiple files to delete

Description of the Functions in the Playback Mode

Gestures in the Playback Mode

1. Hide/display the icons: Single finger tap the photo or video once.
2. Zoom in: Quickly tap the photo twice or use two fingers apart to expand the photo (Sliding a finger to move around the photo).
Zoom out: Quickly tap the photo twice again, and it will restore the original size or use two fingers folded to reduce the photo.

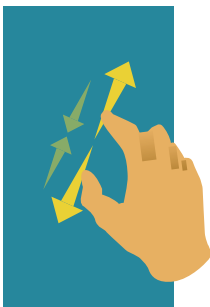

3. Browse fore-and-aft files: Slide around with one finger.

Rotate  (Smart device single playback mode)

Rotate the photo by 90°.

Tap , the photo will rotate 90 counter-clockwise each time this icon is pressed.

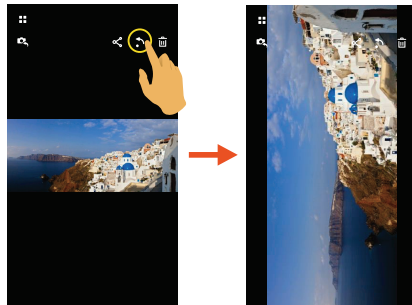

Select One or More File(s) (Camera and Smart device index playback mode)

1. Long press a file thumbnail to enter the multiple-selection screen.
2. View fore-and-aft files by sliding a finger up and down on the screen.

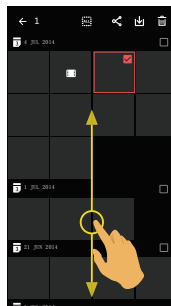
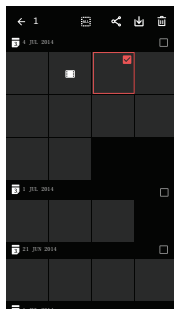
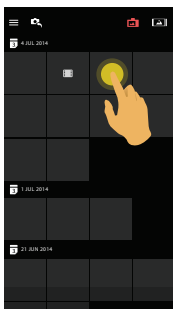

3. Select one or more file(s).

3.1. Tap after date folder (**3**) to select all files under the date folder;

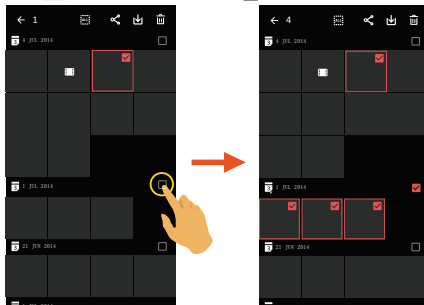

3.2. Tap a file thumbnail to select a single file (tap again to cancel the selection);

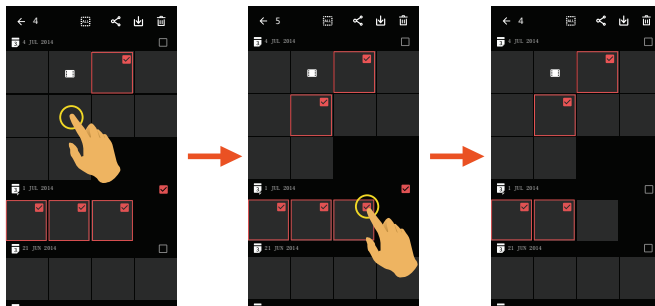

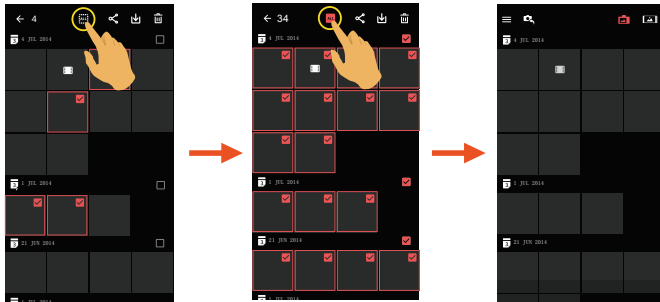

3.3. Tap **ALL** to select all files; tap **ALL** to cancel the selections and return to the index playback interface.



Download



Download the photos or movie in the camera to your smart device.

Camera Single playback mode:

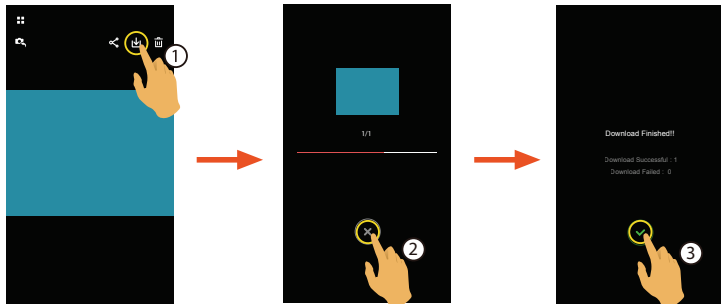
1. Select the file you want to download, and tap  to start downloading.
2. Tap  in the downloading process, and select “Yes” in the pop-up interface to cancel downloading.
3. After downloading is complete, tap  to return to the playback interface.





Camera index playback mode:

1. Select one or more file(s) you want to download, and tap  to start downloading.
2. Tap  in the downloading process, and select “Yes” in the pop-up interface to cancel downloading.
3. After downloading is complete, tap  to return to the playback interface.

Share

Share the photos or videos to the social network site.

Camera single playback and index playback mode:

1. Select one or more file(s) you want to share, and tap  to start downloading.
2. Tap  in the downloading process, and select “Yes” in the pop-up interface to cancel downloading.
3. After the download is completed, the photos or videos on the smart device can be shared.
 - When the mobile data network is open: Select the social network site to share.
 - Mobile data network not open:
 - iOS system
Please share according to the interface prompt.
 - Android system

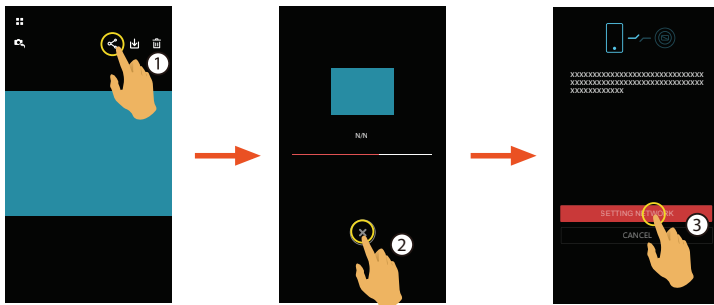

[SETTING NETWORK] : Open mobile data network or Wi-Fi for internet access.
[CANCEL] : Cancel sharing.



After the “SETTING NETWORK” is selected and the network is switched, the interface has 3 options:

“SETTING NETWORK”: change the network settings.

“SHARE”: select the social network site to share.

“CANCEL”: cancel sharing.



When the network is changed, the App will close automatically.

Smart device single playback and index playback mode:

Please share according to the operating methods for sharing in single playback and index playback mode of the camera.

Delete

Delete the selected photos or videos.

Camera and Smart device index playback mode:

1. Select one or more file(s) you want to download, and tap .
2. Select “DELETE” to confirm the deletion in the pop-up prompt screen.

Camera and Smart device single playback mode:

1. Select the file you want to delete, and tap .
2. Select "DELETE" to confirm the deletion in the pop-up prompt screen.

Android system

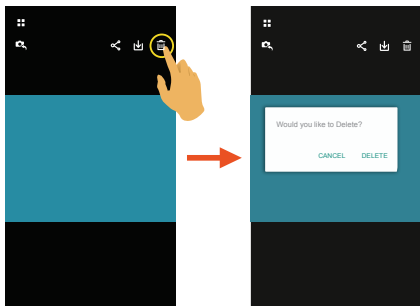



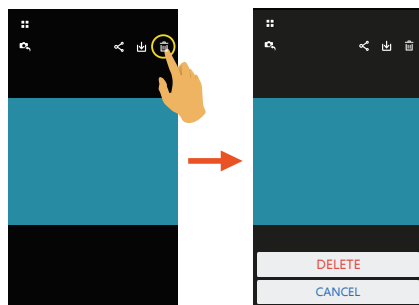

iOS system



Play the Video (Camera and Smart device single playback mode)

Slow wireless transmission may impact viewing. We suggest downloading the file to your device before viewing.

1. Tap  to play the video.
2. Tap  to pause the video.
3. Tap  to continue the video.
4. Tap  to return to the previous interface.

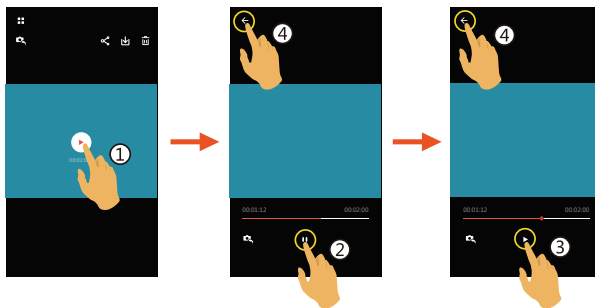

Android User Notification:

To ensure proper playback of video files created with the KODAK PIXPRO SP1 Digital Camera, we suggest using the MX Player application.

1. Download and install MX Player to your Android smart devices.
Download link: <https://play.google.com/store/apps/details?id=com.mxtech.videoplayer.ad>
2. Run MX Player.
3. Choose "Decoder" under "Settings" and check the options as shown in the pictures.

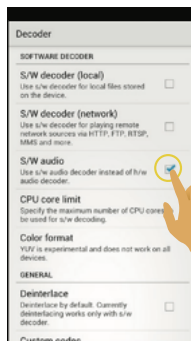
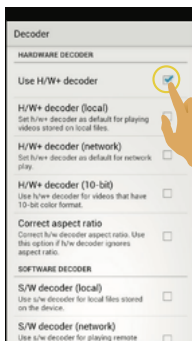
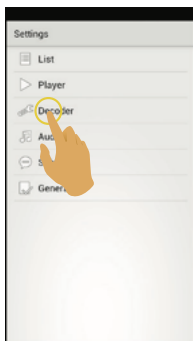

★ The following video applications will also work: VPlayer, VLC for Android, BSPlayer Free.

Menu ☰ (Camera and Smart device index playback mode)

1. Tap ☰ or slide from the left to the right of the screen to display the menu.
2. Tap your desired setup item.
3. Tap the option to return to the menu.
4. Tap ← to return to playback interface.

YouTube

This option is only under the iOS system.

About

See Page 64 for explanations.

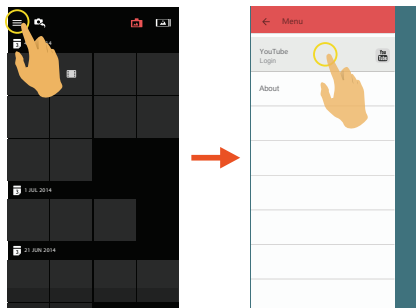

Connection Port Introduction

Connect a Computer

The product can be connected to the computer using a USB cable to allow for copying the files from the product into the computer.

Steps:

1. Open the rear cover of the product, connect one end of the USB cable to the computer (the computer needs to be in on state) and the other end to the USB port of the product;
2. The product display will show a rolling connection cartoon. The computer will automatically sense the product.
3. Open the folder of the product on the computer and copy the data you need to the computer.
4. After transmission is completed, please cancel the USB connection by safely pulling out the USB device from the computer system;
5. Pull out the USB cable. The product will automatically shut down.

The product supports Windows operating systems (Windows XP, Windows Vista , Windows 7, and Windows 8) and the Mac operating system.

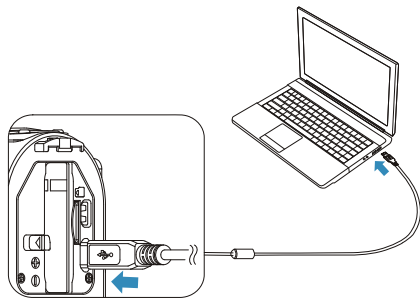



If connected to the computer USB port of 100mA, the product will have no response due to insufficient power supply.



Pressing  for more than 2 seconds will cause shut-down and stop of communication between the computer and the product.



If a memory card is inserted in the product, only files in the memory card will be read. If needing to read the files in the internal memory, please pull out the memory card before connecting to the computer.

HDMI Connected TV Output



The product is capable of realizing movie and photo playback on a TV through HDMI.

The HDMI connection defaults to automatic connection mode.

Steps:

1. Open the rear cover of the product, connect one end of the HDMI cable (not included) to a TV which is up to the HDMI standard (the TV and the product both need to be turned on) and the other end to the cable to the HDMI port of the product;
2. The product will automatically enter the playback state after the connection is complete. The operating method is the same as the [Introduction to Basic Operation of Playback] on page 31.



If the product is connected to the TV while in the off state, press and hold  and  to power on. The product will automatically enter the playback state.

Appendices

Specifications







「Design and specifications are subject to change without notice.」





Active Pixels		14.24 Megapixels
Total Pixels		15.31 Megapixels [1/2.33" MOS]
Lens	Focal Length	3.0mm
	Equivalent to 35mm film	16.8mm
	F number	F2.8
	Lens Construction	6 groups 6 elements
	Optical Zoom	Fixed focus
	Focusing Range	Normal: 60cm ~ ∞
Field of View		Ultra Wide, Medium, Narrow, Water Ring
Anti-Handshake		EIS
File Format	Still Image	Exif 2.3 (JPEG)
	Movie	Movie Format: MOV (H.264), Audio: Linear PCM (Stereo)



Image Dimensions	Still Size	(4:3) 14MP: 4320×3240 5MP: 2592×1944	(16:9) 10MP: 4320×2432
	Movie Size	1920×1080(30fps), 1280×960(50fps), 1280×960(30fps), 1280×720(60fps), 1280×720(30fps), 848×480(60fps) High-Speed Movie: 848×480(120fps)	
Detection Features		Face detection	
Waterproof Feature		Up to 10 m underwater	
Shockproof Feature		Up to 2 m	
Dustproof Feature		Equivalent to JIS / IEC (IP6X)	
Freeze-proofing Feature		-10°C	
Wireless		Supported	
LCD Screen		1.5 inch (115k Pixels)	
ISO Sensitivity		Auto (100 ~ 800)	
Exposure Metering Method		Artificial Intelligence AE (AiAE), Face AE	
Exposure Control Method		Program AE	





Burst Shot	Supported
Playback Modes	Single Photo
White Balance	Auto (AWB), Daylight, Cloudy, Fluorescent, Underwater
Storage Media	Internal Memory: Approx. 100 MB
	Micro SD / Micro SDHC Card (Up to 32GB Support) \ [MMC Card not supported]
Language Support	Support 27 languages: English, Chinese (simplified and traditional), Japanese, Korean, French, Spanish, Portuguese, Thai, Indonesian, Vietnamese, Italian, German, Dutch, Russian, Polish, Swedish, Danish, Finnish, Norwegian, Greek, Turkish, Hungarian, Croatian, Czech, Arabic, Hindi
Interface	USB 2.0 (Micro 5 pin USB) , HDMI (Type D)
Power supply	Rechargeable Li-ion Battery LB-080, 3.6V 1250mAh, In-action cam Charging
Battery Performance	Approx. 350 Shots (Based on CIPA Standards); Approx. 130 min for Video (@1080p/30fps)
Operation Environment	Temperature: -10 ~ 40°C, Humidity: 0 ~ 90%
Dimensions	84.7×51.4×39.5mm (Based on CIPA Test Standards)
Weight	Approx. 155g (excluding battery and memory card)

Prompts and Warning Messages

Message	Description	Reset Mode
	<ul style="list-style-type: none"> ■ When using “Copy to card”, if the number of folders in the memory card exceeds the maximum number of folders (999), the copy and access actions cannot be performed. ■ This message indicates that a long read time may be caused due to too many folders in the product. ■ During shooting, if the files or folders have reached the maximum number (9999 for files, 999 for folders), the memory card cannot be accessed. 	<ul style="list-style-type: none"> ■ End the message after the product processing. ■ End the message after the product processing. ■ The message will disappear after 2 seconds.
	<ul style="list-style-type: none"> ■ When the file is protected, the message will appear on the screen if the delete action is performed. 	<ul style="list-style-type: none"> ■ The message will disappear after 2 seconds.
	<ul style="list-style-type: none"> ■ When turning on the product or pressing  , the product detects that the memory card is out of space. 	<ul style="list-style-type: none"> ■ The message will disappear after 3 seconds.

Message	Description	Reset Mode
	<ul style="list-style-type: none"> ■ When turning on the product or pressing , the product detects that the internal memory is out of space. 	<ul style="list-style-type: none"> ■ The message will disappear after 3 seconds.
	<ul style="list-style-type: none"> ■ Updating firmware. 	<ul style="list-style-type: none"> ■ User should do nothing. The product will turn off automatically after the update is completed.
	<ul style="list-style-type: none"> ■ The memory card still cannot be recognized after format. ■ An error occurs when reading the memory card. ■ Interruption logging problem is encountered in the period of writing in the memory card or recording in the video recording or shooting process. 	<ul style="list-style-type: none"> ■ The message will disappear in 2 seconds, and the screen of format or not will appear. ■ The message will disappear in 2 seconds, and the screen of format or not will appear. ■ Return to the viewfinder status will be displayed in 2 seconds.

Message	Description	Reset Mode
	<ul style="list-style-type: none"> ■ The internal memory still cannot be recognized after format. ■ Interruption logging problem is encountered in the period of writing in the memory card or recording in the video recording or shooting process. 	<ul style="list-style-type: none"> ■ The message will disappear in 2 seconds, and the screen of format or not will appear. ■ Return to the viewfinder status will be displayed in 2 seconds.
	<ul style="list-style-type: none"> ■ When a memory card lower than Class 4 is used to record a HD or above movie, the writing speed is too slow and recording will not continue. 	<ul style="list-style-type: none"> ■ Cancel the message and return to the viewfinder status in 4 seconds.
	<ul style="list-style-type: none"> ■ The time of file processing (imaging processing, in synthesis, in saving, edition after-processing, archiving coping, in Format and the like) exceeds 2 seconds. 	<ul style="list-style-type: none"> ■ The message will disappear after the operation is completed.





Message	Description	Reset Mode
	<ul style="list-style-type: none"> ■ Connecting to the computer USB. ■ Connecting to the HDMI device. 	<ul style="list-style-type: none"> ■ The display is ended after connection is succeeded.
	<ul style="list-style-type: none"> ■ Caution will appear before power off when the battery of the product is already dead. ■ The firmware cannot be updated when power is insufficient. 	<ul style="list-style-type: none"> ■ It will shut down after displaying for 2 seconds. ■ A message appears to prompt updating after full charging and returning to the update screen.
	<ul style="list-style-type: none"> ■ The message will be displayed when the temperature of the battery reaches 70 °C during recording. 	<ul style="list-style-type: none"> ■ It will shut down automatically in 2 seconds, and can be recovered to use only after the temperature is reduced.
	<ul style="list-style-type: none"> ■ When the AP setting is enabled, the message will be displayed when the temperature of the battery is in the range from 68 to 70 °C. 	<ul style="list-style-type: none"> ■ Return to the menu interface in 2 seconds and recover use only after the temperature is reduced.

Trouble Shooting

Problem	Possible causes	Solution
Product does not turn on	<ul style="list-style-type: none">■ The battery has been depleted.	<ul style="list-style-type: none">■ Charge the battery.
Exceeded maximum folder number	<ul style="list-style-type: none">■ If the files or folders have reached the maximum number (9999 for files, 999 for folders), the memory card cannot be accessed.	<ul style="list-style-type: none">■ Copy the data to the computer disk, and format the memory card using the product.
Writing speed of the memory card is slow	<ul style="list-style-type: none">■ When a memory card lower than Class 4 is used to record a HD or above movie, the writing speed will be slower and recording will not continue.	<ul style="list-style-type: none">■ Use a higher-class memory card, or format this card before shooting.
Too many videos to process	<ul style="list-style-type: none">■ The number of pictures or folders in the memory card exceeds the specifications, so the playback cannot be displayed or played back by date.	<ul style="list-style-type: none">■ Delete unwanted files.
High temperature warning	<ul style="list-style-type: none">■ Battery overheat.	<ul style="list-style-type: none">■ Remove the battery when the product is turned off. Continue to use the battery when it cools.

Special Accessories

Let the action cam accommodate to your activity, there are different options of accessories available. Accessories bundle vary per distribution retailer. To purchase additional accessories separately, please contact your local retailer customer service support, or visit <http://kodakpixpro.com> for more customer service details.

-  Before using (especially in water or strenuous activity), please pay attention to make sure the product is tightly secured to prevent damage or loss to the product.
-  Please ensure that the adhesive surface is clean before using double-sided adhesive accessories. Dirt, grease, or other foreign matter will reduce the effectiveness of the double-sided adhesive.
-  After fully assembling the accessories, please check to make sure that the screw and pre-tightening handle are in the proper position and fully secure.
-  For ease of assembly, please line up the marks on the base and pre-tightening handle per the diagrams below.

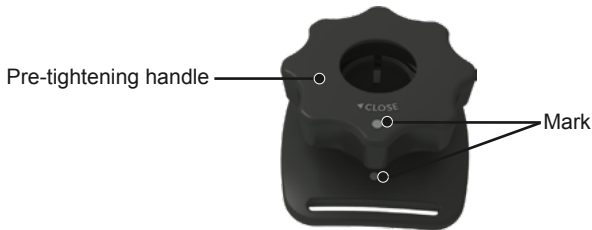



Adhesive mount (flat) : accessory applicable to skateboard



Adhesive mount (curved) : accessory applicable to helmet



Installation Method:

There are two types of adhesive mounts: flat and curved. You may select based on the shape of the object to be used.

Both types can be assembled in the same way, taking the adhesive mount (flat) as an example:

1. Align the location pole of the base to the location hole of the action cam, and align the screw on the base to the tripod socket of the action cam. Rotate the screw for fixing.

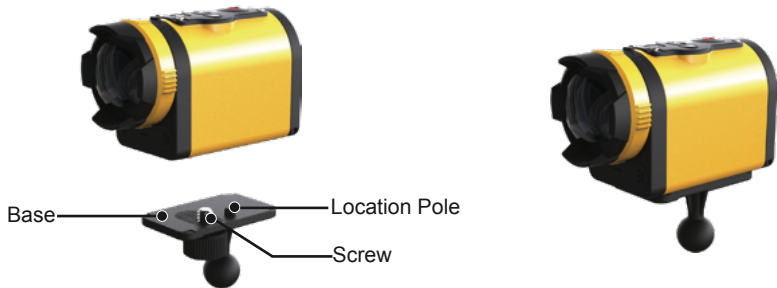

-
2. Tie one end of the tether to the adhesive mount, and the other end to the rear cover shaft.
3. Assemble the base, pre-tightening handle and adhesive mount according to the direction illustrated in the picture. First press the base into the adhesive mount, and then rotate and tighten the pre-tightening handle.



-
-
-
4. Tack the double-sided adhesive at the bottom of the adhesive mount to the object to be used.



Double-sided adhesive is disposable. It can be purchased separately and replaced if needed.

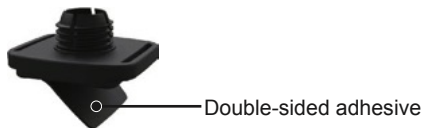

Bar mount: accessory applicable to bicycle



Installation Method:

1. Set the bar clamp to the handlebar, and rotate the screw for fixing.



2. Open the bottom part of the fixing sleeve and set it in the Action Cam. Insert the connector into the bottom part of the fixing sleeve, and then tighten them with screw.



3. Assemble the base, pre-tightening handle and bar clamp according to the direction illustrated in the picture. First press the base into the bar clamp, and then rotate and tighten the pre-tightening handle.

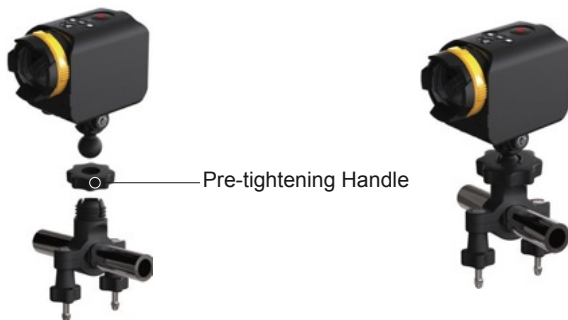

Suction cup mount: accessory applicable to be attached to the automotive windshield (or smooth surface)



Installation Method:

1. Align the location pole of the base to the location hole of the action cam, and align the screw on the base to the Tripod Socket of the action cam. Rotate the screw for fixing.

2. Assemble the base, pre-tightening handle and suction mount according to the direction illustrated in the Picture. First press the base into the suction cup mount, and then rotate and tighten the pre-tightening handle.

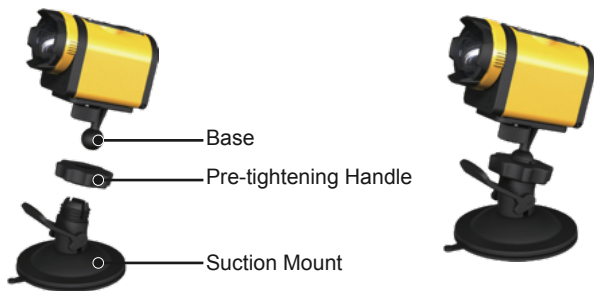

3. First, clean the suction mount and the windshield, and then attach the suction cup to the windshield (or smooth surface). Press the handle to make it attached to the windscreen.



Vented helmet strap mount-A: accessory applicable to bicycle helmet



Installation Method:

1. Expand the band first, and then thread both ends of the band into the helmet.



Band



2. Thread both ends of the band into the buckle, and then press the buckle clamp.

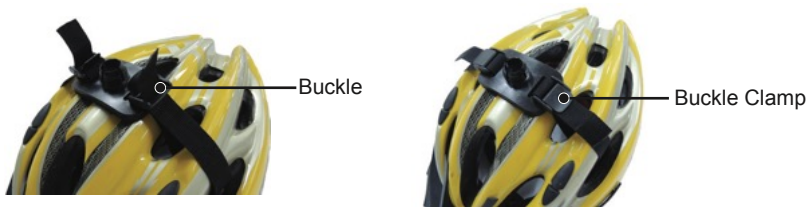

3. Align the location pole of the base to the location hole of the action cam, and align the screw on the base to the tripod socket of the action cam. Rotate the screw for fixing.
4. Assemble the base, pre-tightening handle and vented helmet strap mount according to the direction illustrated in the picture. First press the base into the vented helmet strap mount, and then rotate and tighten the pre-tightening handle.

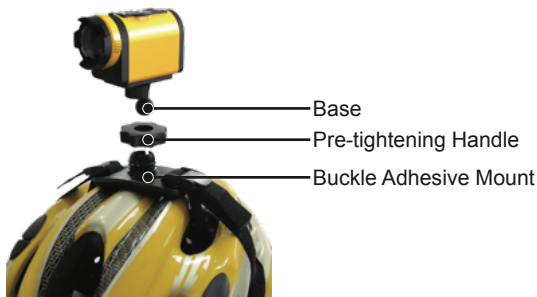

Vented helmet strap mount-B: accessory applicable to bicycle helmet



Installation Method:

1. Align the location pole of the mount to the location hole of the action cam, and align the screw on the holder to the tripod socket of the action cam, and then rotate the screw with a tool like a coin to fasten.

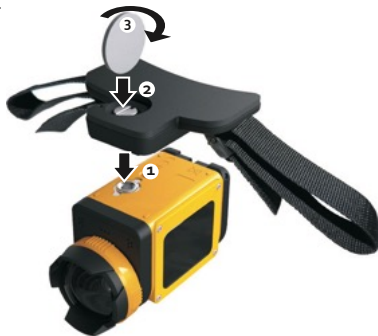

2. Expand the band first, and then thread both ends of the band into the buckle. Thread both ends of the band into the buckle, and then press the buckle clamp



Handheld mount : accessory applicable to be handheld



Installation Method:

1. Align the location pole of the mount to the location hole of the action cam, and align the screw on the holder to the tripod socket of the action cam, rotate the screw for fixing.

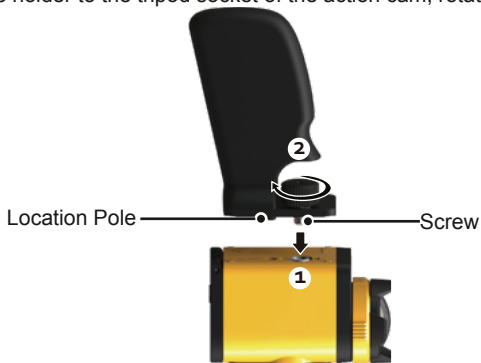

Surfboard adhesive mount: accessory applicable to surfboard

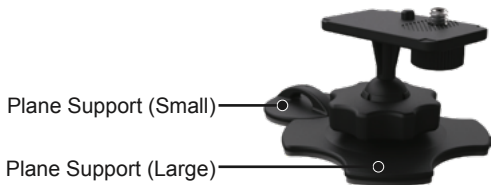

Installation Method:

1. Align the location pole of the base to the location hole of the action cam, and align the screw on the base to the Tripod Socket of the action cam. Rotate the screw for fixing.
2. Tie one end of the tether to the plane support (small), and the other end to the rear cover shaft of the action cam.

3. Assemble the base, pre-tightening handle and plane support (large) according to the direction illustrated in the Picture. First press the base into the plane support (large), and then rotate and tighten the pre-tightening handle.

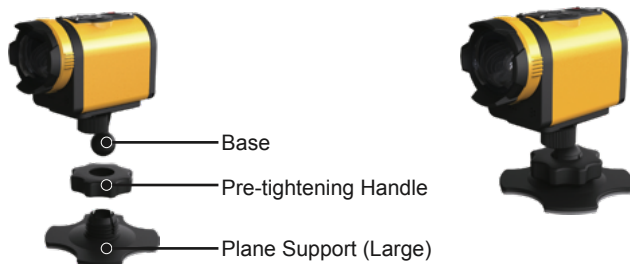

4. Tack the double-sided adhesive at the bottom of the plane support (large) and the plane support (small) to the object to be used.



Double-sided adhesive is disposable. It can be purchased separately and replaced if needed.



Head strap mount : accessory applicable to mount the action cam on your head



Installation Method:

1. Insert the angle bracket into the mount, align the location pole on the angle bracket to the location hole of the action cam, and align the screw on the angle bracket to the tripod socket of the action cam. Rotate the screw for fixing.



2. Set the band to your head and adjust the degree of tightness.



If you need to remove the mount, please use one hand to push forward the angle bracket (as directed by arrow ①), and use a pointed object to push the buckles in the two side holes by order with another hand (as directed by arrow ②). Then remove the angle bracket out from the mount.



Extended Arm:

You can add one or two extended arms (except head bank mount) to each kit, to help you to adjust the mounting angle of the action cam more flexibly.

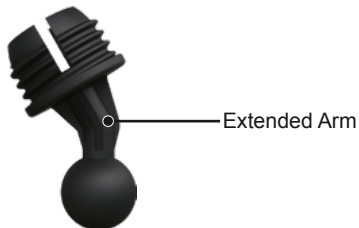



The Kodak trademark and trade dress are used under license from Kodak.

© 2013 JK Imaging Ltd. All Rights Reserved.

JK Imaging Ltd., 17239 So. Main Street, Gardena, CA 90248 USA

JK Imaging Europe, 71 Clarendon Road, Watford, WD17 1DS, UK

<http://kodakpixpro.com>